

ALISEO GmbH
G E R M A N Y

2022 / VOLUME 2

THE FINE ART OF HOSPITALITY

ALISEO GmbH
G E R M A N Y

KATALOG / CATALOGUE 2022

TRADITION & INNOVATION



Gegründet von / Foundet by
Claus Michael Hellfritz

1985 /

The World's Safest Hair Dryer

1990 / The PRO

1st Pistole/Holster Design
Haartrockner mit einem Pistolen /
Holster Design

1993 / Biltmore Collection

Globale inspirierte Kosmetikspiegel /
Globally inspired cosmetic mirrors

1996 / Bad-Accessoires/
Bathroom Accessories

Hotelperfektion
Klares Design, definierte Funktionen /
Clean designs/defined functions

2002 / LED Spiegel/Mirrors

Klassisch inspiriert und elegant effizient /
Classically inspired and elegantly efficient

2012 / China-Büro/Office

Aliseo eröffnet Büro in Shanghai /
Aliseo opens Shanghai office

2015 / Neuer Hauptsitz /
New Headquarters

Umzug nach Gengenbach /
Relocates to Gengenbach

2018 / German Design Award

Ausgezeichnet für hervorragendes Pro-
duktdesign /
Received for excellence in product
design

2020 / NU finishes

Eine unendliche Vielfalt an PVD-Farben
und -Oberflächen /
An endless variety of PVD colors and
finishes



NINA HELLFRTITZ-LANGE UND JAN HELLFRTITZ

Blicken mit dem Wissen der Vergangenheit in die Zukunft /
Looking to the Future with the Knowledge of the Past



ALISEO

A NEW CULTURE OF HOSPITALITY

Seit über 35 Jahren steht ALISEO an der Spitze einer neuen Kultur der Gastfreundschaft. Eine Evolution traditioneller Formen, bei der die effiziente Neuerfindung von Luxus ein ästhetisches Refugium für den Genuss des Gastes schafft. Modische Lösungen, deren stilistische und geometrische Vielfalt einen Raum in ein Statement des persönlichen Designs verwandelt.

Aliseo bietet technologische Innovation und hochmoderne Ästhetik für eine anspruchsvolle Klientel, die in seinem Design die Exklusivität ihrer Identität findet. Aliseo verbindet zeitgenössisches Aussehen mit traditionellen Werten und versteht die Integrität und Beziehungen verschiedener Materialien, die Klarheit des Zwecks mit utilitaristischer Schönheit zu verbinden.

Die global inspirierten Produkte von Aliseo führen den Hotelier in eine neue Welt der Gestaltungsmöglichkeiten und bieten mehr Flexibilität, ästhetische Leistung und Designfreiheit. Während einige Kontraste stark sind, ist das Gefühl rhythmisch, dynamisch und faszinierend.

Wir heißen Sie in unserer Welt willkommen. /

For over 35 years ALISEO has been at the forefront of a New Culture of Hospitality. An evolution of traditional shapes and forms where the efficient reinvention of luxury creates an aesthetic refuge for the enjoyment of the guest.

Fashionable solutions whose stylistic and geometric diversity transforms a room into a statement of personal design.

Aliseo offers technological innovation and cutting-edge aesthetics to a demanding clientele who finds in its design the exclusiveness of their identity. A stunning display of contemporary looks and traditional values, Aliseo understands the integrity and relationships of different materials that combine clarity of purpose with utilitarian beauty.

Aliseo's globally inspired products take the hotelier to a new world of design possibilities offering greater flexibility, aesthetic performance and design freedom. While some contrasts are powerful, the feeling is rhythmic, dynamic and intriguing.

We Welcome You to Our World.

Aus dem Schwarzwald - wo Qualität und Handwerkskunst noch Tradition haben /
From Germany's Black Forest - where quality and craftsmanship are still a tradition

INHALT



CONTENT

HOTEL-HAARTROCKNER / HAIR DRYERS	10-43
Black Mambo 1878	16-19
Polarfox 1875	20-23
Carbonic 1900	24-27
Nostalgie Ionic	28-29
Chromo	30-33
Air 1800	34-35
Phoenix	36-37
Pro	38-39
KOSMETIKSPIEGEL / COSMETIC MIRRORS	44-97
LED Moondance	46-51
NUfinishes	54-59
LED ME & MY	60-65
LED Saturn	68-69
LED Cubik	70-73
Cosmo Cubik	74-75
LED Vision	76-77
Minimalist	78-79
FACE	80-81
FACE plus	82-83
LED Interface	84-87
LED City Light	88-89
LED Lunatec	90-91
Concierge Collection	92-93
HOTELBAD-ACCESSOIRES / BATHROOM ACCESSORIES	98-169
Linien / Lines	
Architecto	102-107
Tecno	108-115
Now	116-121
Nexus	122-131
Maxima	132-139
Complementary	144-155
Badezimmerhocker / Bathroom Stools	156-157
Hygieneeimer / Waste Bins	158-165
Personenwaagen / Scales	166-169
GÄSTEZIMMER / GUESTROOM	170-215
Wasserkocher / Water Kettles	172-179
Tablett-Sets / Tablet Sets	180-185
Leder Accessoires / Leather Accessories	186-211
Kofferablagen / Luggage Racks	212-215
BÜGELSTATIONEN / IRONING STATIONS	216-233
Bügeleisen / Irons	216-221
Bügelstationen / Ironing Centers	222-233

HOTEL HAARTROCKNER



HOTEL HAIR DRYERS

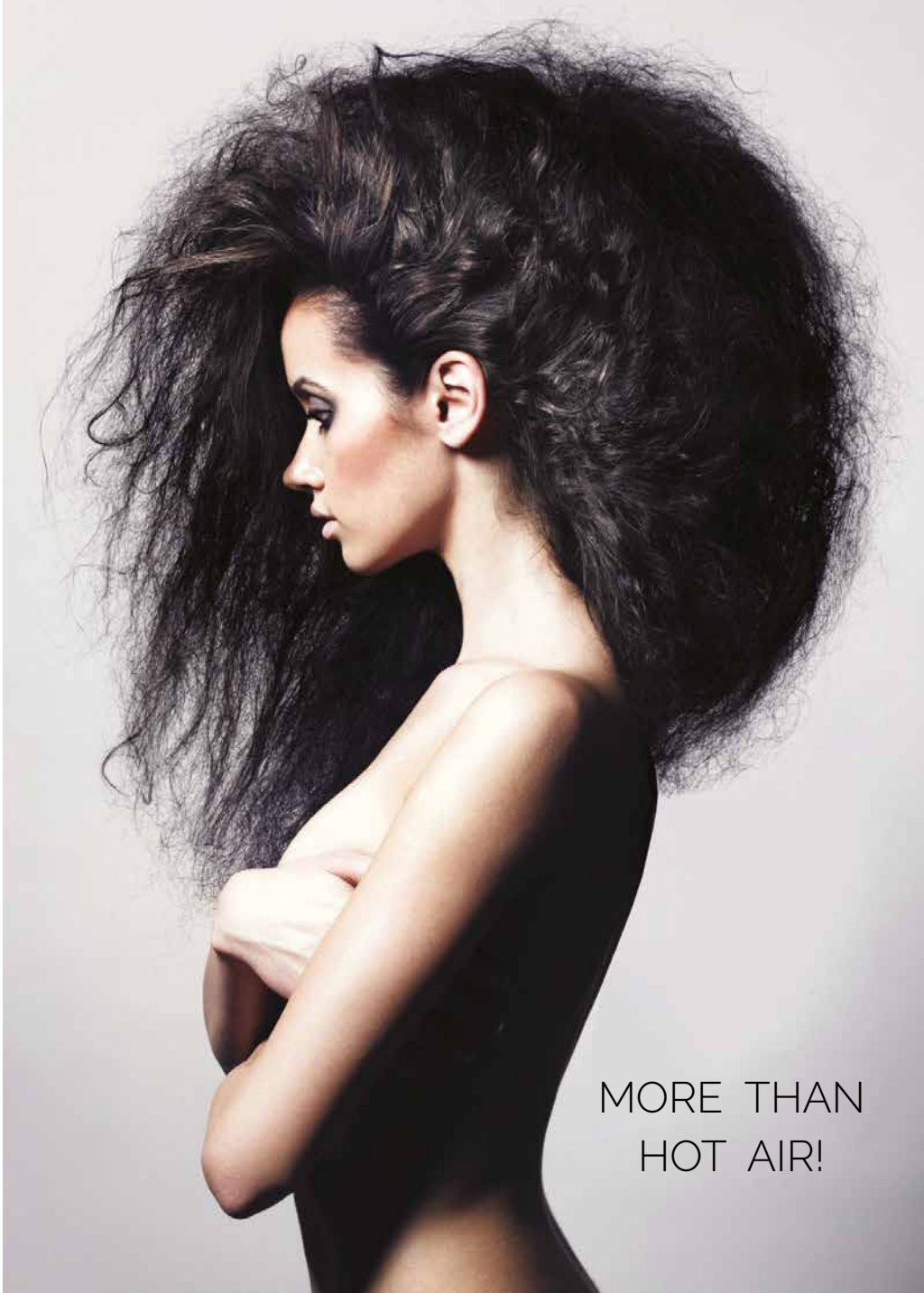

MORE THAN
HOT AIR!



Engineered for Excellence

Aliseo's neueste Generation von Luxus Performance Haartrocknern ist das Zusammenspiel aus italienischem Feingefühl für Formsprache und Aliseo's kompromisslose, technische Standards in Bezug auf Technik und Langlebigkeit. Wahlweise in verschiedenen Farben und Oberflächen ergeben sich eine Vielzahl von Einsatz- und Kombinationsmöglichkeiten. Alle Modelle sind auch zur festen Wandmontage mit Direktanschluss erhältlich. ✓

Our new line of Luxury Performance Hair Dryers has incorporated the essence of Italian design with the rigorous demands of Aliseo engineering. Engineered for maximum air flow, minimum weight, low vibration and extended life. Peerless performance and drying efficiency is enhanced by a high speed motor assembly and an on-board Ion emitter that decreases drying time and locks in moisture for a healthier gentler drying experience. Available in an attractive array of different colors and finishes. With a choice of holders for hard wire installations.

PERFORMANCE
by DESIGN



Luxury Performance

hair

Dryers



IONIC TECHNOLOGY

"Trocknet das Haar ohne es auszutrocknen!"

Eine schonende und effiziente Trocknungsmethode, die die Feuchtigkeitsbalance wieder herstellt, die Nährstoffe einschließt und die Haaroberfläche versiegelt.

Benötigt **30% weniger Energie und 50% weniger Trocknungszeit!** /

"Dries Hair without Drying It Out!"

Ionic Technology is a gentler more efficient drying method that restores moisture balance: locking-in natural nutrients.

Requires **30% less energy and 50% less drying time!**

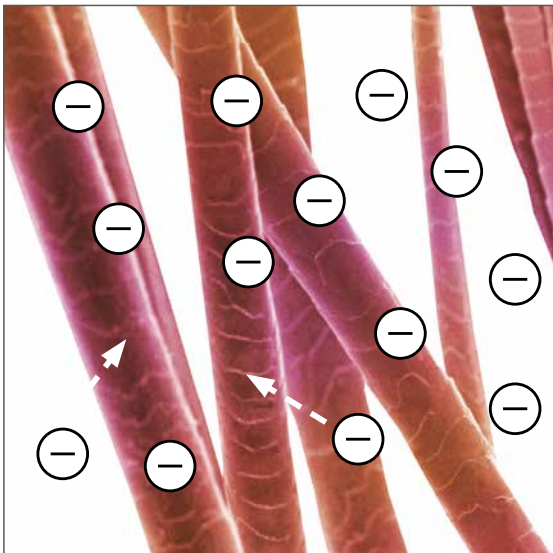

Erzeugung negativer Ionen, die die Wassermoleküle aufbrechen und die Feuchtigkeit tief in das Haar eindringen lassen. Ionen verschließen die Schutzschicht; die Feuchtigkeit wird bewahrt. Die Haaroberfläche wird geglättet und versiegelt, Feuchtigkeit und Nährstoffe bleiben im Haar. /

Converts air stream into negative ions that break large water drops into smaller droplets. Moisture is evaporated gradually locking in nutrients for a healthier, shinier fuller body of hair.

IONEN-TECHNOLOGIE

- Negative Ionen im Luftstrom wandeln positive Teilchen um, keine elektrostatische Aufladung.
- Ionen brechen die Wassermoleküle auf.
- Haaroberfläche wird geglättet und versiegelt, Feuchtigkeit und Nährstoffe bleiben im Haar.
- Feuchtigkeitsgleichgewicht im Haarfollikel wird wieder hergestellt.
- Eine sanfte und schonende Trocknungsmethode, die 30 % weniger Hitze und 50 % weniger Zeit benötigt.

IONIC TECHNOLOGY

- Converts air stream into negatively charged ions – no electrostatic charge.
- Negative ions break large droplets into much smaller water droplets.
- Smaller water droplets are more quickly absorbed into the hair – hair is dried quicker.
- Ions seal the outer coating of the hair follicle locking in nutrients.
- Adds a conditioning effect as moisture balance is restored.

- Gleichmäßige Wärmeverteilung durch konzentrische Spiralheizung
- Integrierter Ionen-Generator verkürzt die Trocknungsdauer und schützt die Haare vor dem Austrocknen. /
- Concentric Heating Coil Secures Even Heat Distribution
- Integrated Ion Emitter - Locks in Moisture And Lessens Drying Time.

- Austauschbarer Haarfilter /
- Removable E-Z Care Hair Filter



- Mehrere Temperatur- und Gebläsestufen für ein professionelles Styling /
- Cold-Shot Function with Multiple Heat/Speed Settings For Maximum Styling

- Optimiertes Lüfterrad für maximale Luftleistung
- Leistungsstarker Hochgeschwindigkeitsmotor /
- Turbo Blade Fan Design Ensures High Volume Air Flow
- Professional High-Speed Motor Assembly

- „Air-Tec“ Düse erhöht Luftleistung
- Ausziehbares 60 cm Spiralkabel
- Inkl. Tasche zur Aufbewahrung in Schublade /
- Air-Tec-Nozzle Increases Air Flow
- Durable 60 cm. Expandable Coil Cord
- Convenient Draw-String Storage Bag

- Angenehme Bedienung der Schaltstufen in der Mitte des ergonomischen Griffes
- Ausgeglichener Schwerpunkt für leichtere Handhabung /
- Comfortable Contoured Handle With Center Controls
- Gravitationally Balanced Weight Distribution For Easier Handling

TECHNOLOGY MEETS DESIGN

Elegante kraftvolle Formen mit zeitlosem Profil kombinieren unvergleichliche Leistung mit Trocknungseffizienz /
Elegantly powerful lines within a contemporary profile combine peerless performance and drying efficiency.

* Unsere Haartrockner sind auf Anfrage mit zusätzlichem Kabel und Stecker zum Anschluss an die Steckdose erhältlich /
Our hair dryers are available with additional cord and plug for plug-in application on request.



BLACK MAMBO 1875

Die besondere Easy-Touch Komfortbeschichtung ist verführerisch weich und angenehm. Der leistungsstarke Motor und die Temperaturstufen können individuell eingestellt werden. Integrierte Ionentechnologie verkürzt den Trocknungsprozess, spart Energie und schützt das Haar vor dem Austrocknen - für ein professionelles Styling wie beim Frisör. /

EZ touch comfort coating with anti-slip protection in a distinctive matt black finish.

Ergonomic housing incorporates high performance motor assembly, Ionic functions and multiple speed controls for the ultimate in professional styling.



01



Easy-Touch Komfortbeschichtung
in schwarz mattem Finish /
EZ Touch Comfort Coating in a
distinctive matt black finish

02



mit Stecker /
plug in



Für die Schublade /
Drawer Solution

BLACK MAMBO

Ionen-Technologie
Drei Temperaturstufen
Zwei Gebläsestufen
Kaltlufttaste
AC-Motor
Abnehmbare Düse
Überhitzungsschutz
Doppelte Isolierung
Schutzklasse II
Spiralkabel, 60 cm

Ionic technology
Three heat settings
Two air speeds
Cold shot button
AC motor
Removable nozzle
Overheating protection
Double insulation
Class II
Coil cord, 60 cm



220-240 V, 50/60 Hz, Cool / 900 / 1875 W

Ohne Halterung. Mit Aufbewahrungstasche
Mit Stecker zum Anschluss an Steckdose /
Without holder. With storage bag
With plug for plug-in application

010492

schwarz, Easy-Touch /
black, EZ touch

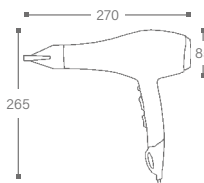

01. Easy-Touch-Komfortbeschichtung für angenehme Handhabung / EZ touch comfort coating with anti-slip protection.
02. Mehrere Schaltstufen & Kaltlufttaste / Variable speed & cold shot controls

BLACK MAMBO 1875



HANG-UP



- 03. Einfaches Einhängen. Integrierte Gelpads verhindern Kratzer /
Hang-up cradle design with gel pad protection
- 04. Langlebiger 1875 Watt AC-Motor /
1875 Watt long-life AC-motor

Wandhalterung mit Netztrennschalter
Direktanschluss /
Wall holder with interrupter switch
Hard wired application

010596 schwarz, Easy-Touch /
black, EZ touch

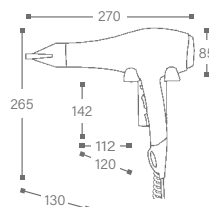



DROP-IN

- 05. Einfaches Einhängen /
Easy Drop-In Design
- 06. Integrierter Silikonring verhindert Kratzer /
Rubber insert guards against scratches
and wear and tear

DROP-IN

Praktische Designhalterung DROP-IN mit Kratzschutz und beleuchtetem Netztrennschalter für zusätzliche Sicherheit. /
Convenient drop-in holder with rubber snug-fit insert to protect against scratches and wear and tear. Illuminated interrupter switch guards against circuit leakage.

Wandhalterung mit Netztrennschalter
Direktanschluss /
Wall holder with interrupter switch
Hard wired application

010598 schwarz, Easy-Touch /
black, EZ touch

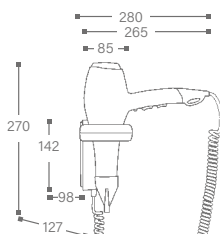



White Air



ION-TECH – 50% weniger Trocknungszeit
 "Trocknet das Haar, ohne es auszutrocknen" /
 ION-TECH – 50% less drying time
 "Dries Hair Without Drying It Out"

POLARFOX

Ionen-Technologie	Ionic technology
Drei Temperaturstufen	Three heat settings
Zwei Gebläsestufen	Two air speeds
Kaltlufttaste	Cold shot button
AC-Motor	AC motor
Abnehmbare Düse	Removable nozzle
Überhitzungsschutz	Overheating protection
Doppelte Isolierung	Double insulation
Schutzklasse II	Class II
Spiralkabel, 60 cm	Coil cord, 60 cm

CE  220-240 V, 50/60 Hz, Cool / 900 / 1875 W

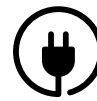

mit Stecker /
plug in



Für die Schublade /
Drawer Solution

Ohne Halterung. Mit Aufbewahrungstasche
 Mit Stecker zum Anschluss an Steckdose /
 Without holder. With storage bag
 With plug for plug-in application

010547 weiß/silber /
white/silver 

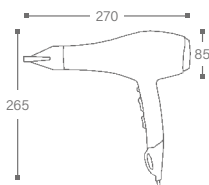

- 01. Langlebiger 1875 Watt AC-Motor /
1875 Watt long-life AC-motor
- 02. Mehrere Schaltstufen und
Kaltlufttaste /
Variable speed and cold shot controls

POLARFOX 1875



DROP-IN

- 03. Einfaches Einhängen /
Easy Drop-In Design
- 04. Integrierter Silikonring verhindert Kratzer /
Rubber insert guards against scratches
and wear and tear

Wandhalterung mit Netztrennschalter
Direktanschluss /
Wall holder with interrupter switch
Hard wired application

010549 weiß/silber /
white/silver

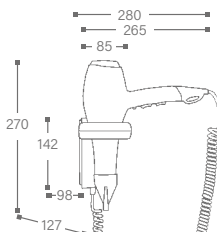



HANG-UP

05. Einfaches Einhängen /
Hang-up cradle design

Wandhalterung mit Netztrennschalter
Direktanschluss /
Wall holder with interrupter switch
Hard wired application

010548 weiß/silber /
white/silver

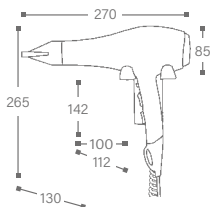





CARBONIC 1900

Perfektion in Karbon, ein optisches Highlight mit ausgereifter Technik. Langlebig, leicht und trotzdem robust. Der leistungsstarke Motor in Verbindung mit den Vorteilen der integrierten Ionentechnik ermöglicht ein professionelles Styling wie beim Frisör. Die Schaltstufen für Temperatur und Gebläse in der Mitte des Griffs lassen sich für Rechts- und Linkshänder gleichermaßen angenehm bedienen. /

A visual alternative to the mainstream. Distinctive carbon optic combines clarity of purpose with utilitarian beauty. Contoured handle with centrally located controls accommodates both left and right hand users. Gravitationally balanced weight distribution maximizes comfort and control.



mit Stecker /
plug in



Für die Schublade /
Drawer Solution

CARBONIC

Ionen-Technologie
Drei Temperaturstufen
Zwei Gebläsestufen
Kaltlufttaste
AC-Motor
Abnehmbare Düse
Überhitzungsschutz
Doppelte Isolierung
Schutzklasse II
Spiralkabel, 60 cm

Ionic technology
Three heat settings
Two air speeds
Cold shot button
AC motor
Removable nozzle
Overheating protection
Double insulation
Class II
Coil cord, 60 cm

Ohne Halterung.
Mit Aufbewahrungstasche
Mit Stecker zum Anschluss an Steckdose /
Without holder. With storage bag
With plug for plug-in application

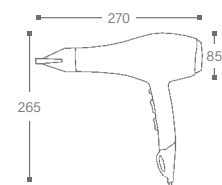

010493

Karbon-Muster /
carbon-pattern



220-240 V, 50/60 Hz, Cool / 950 / 1900 W

CARBONIC 1900



A Stylistic Evolution



HANG-UP



- 01. Ausführung in Karbonoptik / High gloss Carbonic Optic
- 02. Einfaches Einhängen. Integrierte Gelpads verhindern Kratzer / Hang-up cradle design with gel pad protection
- 03. Austauschbarer Haarfilter / Removable E-Z Care Hair Filter

Wandhalterung mit Netztrennschalter
Direktanschluss /
Wall holder with interrupter switch
Hard wired application

010502 Karbon-Muster /
carbon-pattern

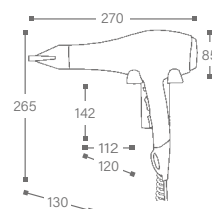



DROP-IN

- 04. Mehrere Schaltstufen und Kaltlufttaste mit Ionenfunktion / Variable speed and cold shot controls
- 05. Einfaches Einhängen / Easy Drop-In Design
- 06. Integrierter Silikonring verhindert Kratzer / Rubber insert guards against scratches and wear and tear

Wandhalterung mit Netztrennschalter
Direktanschluss /
Wall holder with interrupter switch
Hard wired application

010543

Karbon-Muster /
carbon-pattern

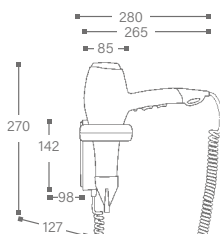

A Contemporary Classic





mit Stecker /
plug in



Für die Schublade /
Drawer Solution

NOSTALGIE IONIC

Ionen-Technologie	Ionic technology
Hotel-Sicherheits-Tastschalter	Hotel safety switch
Zwei Schaltstufen	Two heat/speed settings
AC-Motor	AC motor
Abnehmbare Düse	Removable nozzle
Metallgehäuse	Metal housing
Überhitzungsschutz	Overheating protection
Doppelte Isolierung	Double insulation
Schutzklasse II	Class II
Spiralkabel, 60 cm	Coil cord, 60 cm



SPIRAL-WANDHALTERUNG
Messing, verchromt /
SPIRAL WALL HOLDER
all brass, chrome-plated



220-240 V, 50/60 Hz 500 / 1000 W

Ohne Halterung.
Mit Aufbewahrungstasche
Mit Stecker zum Anschluss an Steckdose /
Without holder. With storage bag
With plug for plug-in application

010331

chrom/schwarz /
chrome/black

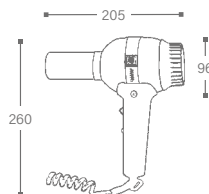

- 01. Metallgehäuse /
Metal housing
- 02. AC-Motor - extra langlebig /
AC-Motor - extra long life

Spiral-Wandhalterung
Mit Stecker zum Anschluss an Steckdose /
Spiral wall holder
With plug for plug-in application

010341

chrom/schwarz /
chrome/black

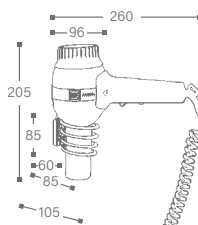



Nouveau Retro



mit Stecker /
plug in



Für die Schublade /
Drawer Solution



Easy-Touch Komfortbeschichtung
in schwarz mattem Finish /
EZ Touch Comfort Coating in a
distinctive matt black finish

CHROMO

Hotel-Sicherheits-Tastenschalter
Zwei Schaltstufen
Abnehmbare Düse
Überhitzungsschutz
Doppelte Isolierung
Schutzklasse II
Spiralkabel, 50 cm

Hotel safety switch
Two heat/speed settings
Removable nozzle
Overheating protection
Double insulation
Class II
Coil cord, 50 cm



220-240 V, 50/60 Hz 600 / 1200 W

Ohne Halterung
Mit Stecker zum Anschluss an Steckdose /
Without holder
With plug for plug-in application

010437

chrom/schwarz, Easy-Touch /
chrome/black, EZ touch 

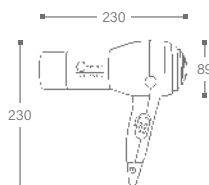

- 01. Mit schmaler Düse für exaktes Styling /
Narrow air concentrator for
pinpoint styling
- 02. Mehrere Schaltstufen /
Variable speed
- 03. Easy-Touch-Komfortbeschichtung /
EZ touch comfort coating
- 04. Komfortabler, rutschfester
Handgriff /
Comfortable ribbed anti-slip handle

CHROMO



Mit Ringhalterung.
Spiralkabel mit Stecker. /
With ring holder.
Coil cord with plug.

010330 chrom/schwarz /
chrome/black

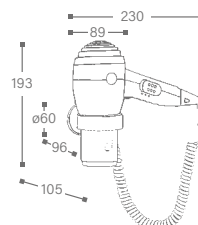



- 01. Wandhalterung, Messing, verchromt
Montage mit Diebstahlschutz /
Wall holder, brass, chrome plated
Wire-thru anti-theft protection
- 02. Netztrennschalter /
Safety security switch
- 03. Lieferung mit schmaler Düse für exaktes
Styling /
Comes with narrow air nozzle for pinpoint
styling
- 04. Gummierter Innenring zum Schutz /
Rubber inner-ring scratch protection
- 05. Design-Halterung mit Kratzschutz /
Low profile holder

Wandhalterung mit Netztrennschalter.
Direktanschluss. /
Wall holder with interrupter switch.
Hard wired.

010407 chrom/schwarz /
chrome/black

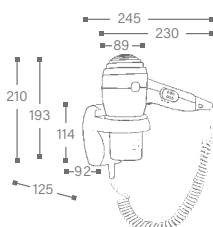



More than Enough

Eine preisgünstige Alternative.

Der AIR 1800 zeichnet sich durch maximalen Luftstrom und sehr geringes Gewicht aus.

Mehrere Temperatur- und Gebläsestufen im sicherem Griff maximieren den Bedienkomfort Ihrer Gäste.

Modernes Profil mit sicherem Griff und pflegeleichtem Luftfilter. /

An economic professional alternative.

The AIR 1800 was engineered for absolute minimum weight and maximum air flow. Multiple settings and sure-grip handle maximizes your guest's comfort and drying control.

Contemporary profile with sure-grip handle and E-Z care mesh filter.





AIR 1800

Drei Temperaturstufen
Zwei Gebläsestufen
Kaltlufttaste
DC-Motor
Abnehmbare Düse
Überhitzungsschutz
Doppelte Isolierung
Schutzklasse II
180 cm langes, glattes Kabel

Three heat settings
Two air speeds
Cold shot button
DC motor
Removable nozzle
Overheating protection
Double insulation
Class II
180 cm straight cord

Ohne Halterung.
Mit Aufbewahrungstasche und Klett-Kabelbinder
Glattes Kabel und Stecker
zum Anschluss an Steckdose /
Without holder. With storage bag and velcro cable tie
With plug for plug-in application

010568 schwarz /
black 

 220-240 V, 50/60 Hz

Cool / 900 / 1800 W

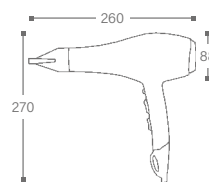



PHOENIX - A modular design ... your choice?

Die modulare Wandhalterung wird allen Anforderungen von Hotelier und Gast gerecht. EcoSmart Design - Maximaler Air Flow durch speziell entwickeltes Lüfterdesign. Eco-Smart 1200 W Heizelement optimiert die Erhitzung der Luft und somit die Effizienz des Trocknungsprozesses. / Modular holder designs meet the various different needs of today's hotelier and their guests. EcoSmart Heating Chamber Design - High-speed pitched blade fan produces a high volume air flow propelling the air rapidly across a sealed heating grid. EcoSmart 1200 W, "Honeycomb" heating element maximizes the heating of the air and the over-all efficiency of the drying process.

Hotel-Sicherheits-Tastschalter / Hotel safety switch
 Zwei Schaltstufen / Two heat/speed settings
 Überhitzungsschutz / Overheating protection
 Doppelte Isolierung / Double insulation
 Schutzklasse II / Class II
 Spiralkabel, 40 cm / Coil cord, 40 cm

PHOENIX

Ohne Halterung /
 Without wall holder



PHOENIX 010235

Ohne Halterung
 Mit Stecker zum Anschluss an Steckdose
 weiß/grau /
 Without holder
 With plug for plug-in application
 white/grey

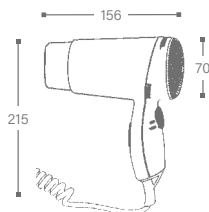

PHOENIX-S

Mit Schukosteckdose /
 With schuko socket



PHOENIX - S 010221

Schukosteckdose
 220-240 V / 16 A / 3600 W
 Wandhalterung mit Netztrennschalter
 Direktanschluss.
 weiß/grau /
 Schuko socket
 220-240 V / 16 A / 3600 W
 Wall holder with interrupter switch
 Hard wired application
 white/grey

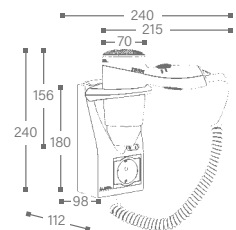

PHOENIX - B
010213

Wandhalterung mit Netztrennschalter
Direktanschluss
weiß/grau /
Wall holder with interrupter switch
Hard wired application
white/grey

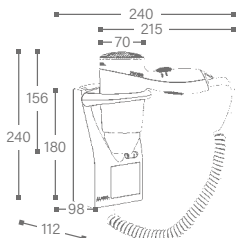

Einfaches Einhängen.
Gelpads verhindern Kratzer.
Modulare Wandhalterung mit
Netztrennschalter /
Hang-up cradle design
with gel pad protection.
Modular holder design with
interrupter switch

PHOENIX-B



PHOENIX-R

Mit Rasiersteckdose /
With shaver socket

PHOENIX - R

Rasiersteckdose 110-220 V max. 20 VA
Wandhalterung mit Netztrennschalter
Direktanschluss /
Shaver socket 110-220 V max. 20 VA
Wall holder with interrupter switch
Hard wired application

010225
weiß/grau / white/grey

010308
chrom/schwarz / chrome/black

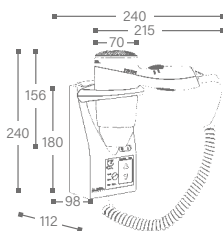

COLOUR OPTIONS

weiß/grau /
white/grey

chrom/schwarz /
chrome/black



All You Need



PRO
The Original





PRO

Hotel-Sicherheits-Tastschalter
Eine Schaltstufe
Überhitzungsschutz
Doppelte Isolierung
Schutzklasse II
Spiralkabel, 40 cm

Hotel safety switch
One heat/speed setting
Overheating protection
Double insulation
Class II
Coil cord, 40 cm

* Dauerhaft, ökonomisch & effizient
Mehr als 500.000 Installationen auf
6 Kontinenten haben seinen legendären
Ruf begründet /
Reliable, economic & efficient
A 20 year track record with
over 500,000 installations on
6 continents

  220-250 V, 50/60 Hz 1200 W

Wandhalterung mit Netztrennschalter
Direktanschluss /
Wall holder with interrupter switch
Hard wired application

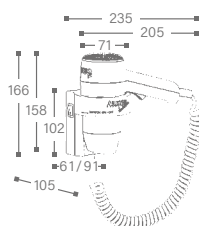

010001

weiß/schwarz /
white/black

TECHNISCHE DATEN / TECHNICAL DETAILS

Alle Haartrockner:

Überhitzungsschutz
Doppelte Isolierung
Schutzklasse II
*1 110 V auf Anfrage
*2 Auch lieferbar mit zusätzlichem
Kabel und Stecker zum Anschluss
an Steckdose

All Hair Dryers:

Overheating Protection
Double Insulation, Class II
*1 110 V upon request
*2 Also available with additional
cord and plug for plug-in
application



CARBONIC 1900
Karbon-Muster
carbon-pattern

BLACK MAMBO 1875
schwarz
black

POLARFOX 1875
weiß/silber
white/silver

Trocknungstechnologie Drying Technology	Ionentechnologie Ionic Technology	Ionentechnologie Ionic Technology	Ionentechnologie Ionic Technology
Besondere Merkmale Special Features		Soft-Touch-Lackierung Rubberized Coating	
Hotel-Sicherheits-Tastschalter Hotel Safety Switch			
Kaltlufttaste Cold Shot Button	■	■	■
Schaltstufen / Wattage Heat/Speed Settings / Wattage	3: Cool / 950 / 1900 W	3: Cool / 900 / 1875 W	3: Cool / 900 / 1875 W
Zusätzliche Gebläsestufen Additional Speed Settings	2	2	2
AC-Motor AC Motor	■	■	■
Halterung mit Netztrennschalter Holder with Interrupter Switch	■	■	■
Direktanschluss Hard Wired	■ *2	■ *2	■ *2
Anschluss an Steckdose Plug-in Application			
Spiralkabel Länge normal / gedehnt Coil Cord Length regular / stretched	60 cm / 150 cm	60 cm / 150 cm	60 cm / 150 cm
Temperatur / Luftstrom / Lautstärke Temperature / Air Flow / Noise Level	74°C / 105 m³/h / 72 dB(A)	74°C / 105 m³/h / 72 dB(A)	74°C / 105 m³/h / 72 dB(A)
Spannung / Frequenz Voltage / Frequency	220-240 V / 50/60 Hz *1	220-240 V / 50/60 Hz *1	220-240 V / 50/60 Hz *1
Prüfzeichen Approvals	CE G	CE G	CE G

Alle Haartrockner:

Überhitzungsschutz
Doppelte Isolierung
Schutzklasse II
*1 110 V auf Anfrage
*2 Auch lieferbar mit zusätzlichem
Kabel und Stecker zum Anschluss
an Steckdose

All Hair Dryers:

Overheating Protection
Double Insulation, Class II
*1 110 V upon request
*2 Also available with additional
cord and plug for plug-in
application



CARBONIC 1900
Karbon-Muster
carbon-pattern

BLACK MAMBO 1875
schwarz
black

POLARFOX 1875
weiß/silber
white/silver

Trocknungstechnologie Drying Technology	Ionentechnologie Ionic Technology	Ionentechnologie Ionic Technology	Ionentechnologie Ionic Technology
Besondere Merkmale Special Features		Soft-Touch-Lackierung Rubberized Coating	
Hotel-Sicherheits-Tastschalter Hotel Safety Switch			
Kaltlufttaste Cold Shot Button	■	■	■
Schaltstufen / Wattage Heat/Speed Settings / Wattage	3: Cool / 950 / 1900 W	3: Cool / 900 / 1875 W	3: Cool / 900 / 1875 W
Zusätzliche Gebläsestufen Additional Speed Settings	2	2	2
AC-Motor AC Motor	■	■	■
Halterung mit Netztrennschalter Holder with Interrupter Switch	■	■	■
Direktanschluss Hard Wired	■ *2	■ *2	■ *2
Anschluss an Steckdose Plug-in Application			
Spiralkabel Länge normal / gedehnt Coil Cord Length regular / stretched	60 cm / 150 cm	60 cm / 150 cm	60 cm / 150 cm
Temperatur / Luftstrom / Lautstärke Temperature / Air Flow / Noise Level	74°C / 105 m³/h / 72 dB(A)	74°C / 105 m³/h / 72 dB(A)	74°C / 105 m³/h / 72 dB(A)
Spannung / Frequenz Voltage / Frequency	220-240 V / 50/60 Hz *1	220-240 V / 50/60 Hz *1	220-240 V / 50/60 Hz *1
Prüfzeichen Approvals	CE G	CE G	CE G

Alle Haartrockner:

Überhitzungsschutz
Doppelte Isolierung
Schutzklasse II
*1 110 V auf Anfrage
*2 Auch lieferbar mit zusätzlichem
Kabel und Stecker zum Anschluss
an Steckdose

All Hair Dryers:

Overheating Protection
Double Insulation, Class II
*1 110 V upon request
*2 Also available with additional
cord and plug for plug-in
application



CARBONIC 1900
010493
Karbon-Muster
carbon-pattern



BLACK MAMBO 1875
010492
schwarz
black



POLARFOX 1875
010547
weiß/silber
white/silver



AIR 1800
010568
schwarz
black

Trocknungstechnologie Drying Technology	Ionentechnologie Ionic Technology	Ionentechnologie Ionic Technology	Ionentechnologie Ionic Technology	Ionentechnologie Ionic Technology
Besondere Merkmale Special Features		EZ Touch-Komfortbeschichtung EZ touch comfort coating		
Hotel-Sicherheits-Tastschalter Hotel Safety Switch				
Kaltlufttaste Cold Shot Button	■	■	■	■
Schaltstufen / Wattage Heat/Speed Settings / Wattage	3: Cool / 950 / 1900 W	3: Cool / 900 / 1875 W	3: Cool / 900 / 1875 W	3: Cool / 900 / 1800 W
Zusätzliche Gebläsestufen Additional Speed Settings	2	2	2	2
AC-Motor AC Motor	■	■	■	
Halterung mit Netztrennschalter Holder with Interrupter Switch				
Direktanschluss Hard Wired				
Anschluss an Steckdose Plug-in Application	■	■	■	■
Spiralkabel Länge normal / gedehnt Coil Cord Length regular / stretched	60 cm / 150 cm	60 cm / 150 cm	60 cm / 150 cm	Glattes Kabel, 180 cm Straight Cord, 180 cm
Temperatur / Luftstrom / Lautstärke Temperature / Air Flow / Noise Level	74°C / 105 m³/h / 72 dB(A)	74°C / 105 m³/h / 72 dB(A)	74°C / 105 m³/h / 72 dB(A)	74°C / 105 m³/h / 72 dB(A)
Spannung / Frequenz Voltage / Frequency	220-240 V / 50/60 Hz *1	220-240 V / 50/60 Hz *1	220-240 V / 50/60 Hz *1	220-240 V / 50/60 Hz *1
Prüfzeichen Approvals	CE GS	CE GS	CE GS	CE GS

Alle Haartrockner:

Überhitzungsschutz
Doppelte Isolierung
Schutzklasse II
*1 110 V auf Anfrage
*2 Auch lieferbar mit zusätzlichem
Kabel und Stecker zum Anschluss
an Steckdose

All Hair Dryers:

Overheating Protection
Double Insulation, Class II
*1 110 V upon request
*2 Also available with additional
cord and plug for plug-in
application



NOSTALGIE IONIC
010331
chrom/schwarz
chrome/black



NOSTALGIE IONIC
010341
chrom/schwarz
chrome/black



CHROMO
010437
chrom/schwarz
chrome/black



CHROMO
010330
chrom/schwarz
chrome/black



CHROMO
010407
chrom/schwarz
chrome/black

Trocknungstechnologie Drying Technology	Ionentechnologie Ionic Technology	Ionentechnologie Ionic Technology	Ionentechnologie Ionic Technology	Ionentechnologie Ionic Technology	Ionentechnologie Ionic Technology
Besondere Merkmale Special Features	Metallgehäuse Metal Housing	Metallgehäuse Metal Housing	EZ Touch-Komfortbeschichtung EZ touch comfort coating	EZ Touch-Komfortbeschichtung EZ touch comfort coating	EZ Touch-Komfortbeschichtung EZ touch comfort coating
Hotel-Sicherheits-Tastschalter Hotel Safety Switch	■	■	■	■	■
Kaltlufttaste Cold Shot Button					
Schaltstufen / Wattage Heat/Speed Settings / Wattage	2: 500 / 1000 W	2: 500 / 1000 W	2: 600 / 1200 W	2: 600 / 1200 W	2: 600 / 1200 W
Zusätzliche Gebläsestufen Additional Speed Settings					
AC-Motor AC Motor	■	■			
Halterung mit Netztrennschalter Holder with Interrupter Switch					■
Direktanschluss Hard Wired					■ *2
Anschluss an Steckdose Plug-in Application	■	■	■	■	
Spiralkabel Länge normal / gedehnt Coil Cord Length regular / stretched	60 cm / 150 cm	60 cm / 150 cm	50 cm / 120 cm	50 cm / 120 cm	50 cm / 120 cm
Temperatur / Luftstrom / Lautstärke Temperature / Air Flow / Noise Level	62°C / 92 m³/h / 78 dB(A)	62°C / 92 m³/h / 78 dB(A)	62°C / 90 m³/h / 76 dB(A)	62°C / 90 m³/h / 76 dB(A)	62°C / 90 m³/h / 76 dB(A)
Spannung / Frequenz Voltage / Frequency	220-240 V / 50/60 Hz *1	220-240 V / 50/60 Hz *1	220-240 V / 50/60 Hz *1	220-240 V / 50/60 Hz *1	220-240 V / 50/60 Hz *1
Prüfzeichen Approvals	TUV GS CE	TUV GS CE	GS CE	GS CE	GS CE

TECHNISCHE DATEN / TECHNICAL DETAILS

Alle Haartrockner:

Überhitzungsschutz
Doppelte Isolierung
Schutzklasse II
*1 110 V auf Anfrage
*2 Auch lieferbar mit zusätzlichem Kabel und Stecker zum Anschluss an Steckdose

All Hair Dryers:

Overheating Protection
Double Insulation, Class II
*1 110 V upon request
*2 Also available with additional cord and plug for plug-in application



PRO
010001 weiß/schwarz
white/black



PHOENIX
010235 weiß/grau
grey white/



PHOENIX - B
010213 weiß/grau
white/grey



PHOENIX - S
010221 weiß/grau
white/grey



PHOENIX - R
010225 weiß/grau
white/grey
010308 chrom/schwarz
chrome/black

Trocknungstechnologie Drying Technology					
Besondere Merkmale Special Features				Schukosteckdose Schuko Socket 220-240 V / 16A / 3600 W	Rasiersteckdose Shaver Socket 110-220 V, max. 20 VA
Hotel-Sicherheits-Tastschalter Hotel Safety Switch	■	■	■	■	■
Kaltlufttaste Cold Shot Button					
Schaltstufen / Wattage Heat/Speed Settings / Wattage	1: 1200 W	2: 600 / 1200 W	2: 600 / 1200 W	2: 600 / 1200 W	2: 600 / 1200 W
Zusätzliche Gebläsestufen Additional Speed Settings					
AC-Motor AC Motor					
Halterung mit Netztrennschalter Holder with Interrupter Switch	■		■	■	■
Direktanschluss Hard Wired	■ *2		■ *2	■	■ *2
Anschluss an Steckdose Plug-in Application		■			
Spiralkabel Länge normal / gedehnt Coil Cord Length regular / stretched	40 cm / 120 cm	40 cm / 120 cm	40 cm / 120 cm	40 cm / 120 cm	40 cm / 120 cm
Temperatur / Luftstrom / Lautstärke Temperature / Air Flow / Noise Level	55°C / 95 m ³ /h / 67 dB(A)	55°C / 95 m ³ /h / 67 dB(A)	55°C / 95 m ³ /h / 67 dB(A)	55°C / 95 m ³ /h / 67 dB(A)	55°C / 95 m ³ /h / 67 dB(A)
Spannung / Frequenz Voltage / Frequency	220-250 V / 50/60 Hz *1	220-240 V / 50/60 Hz *1	220-250 V / 50/60 Hz *1	220-250 V / 50/60 Hz *1	220-250 V / 50/60 Hz *1
Prüfzeichen Approvals					

Die **HAARTROCKNER-GARANTIE** von 2 Jahren gilt nicht für Spa-Anwendungen oder Anwendungen, die eine kontinuierliche Nutzung darstellen können - Friseursalons, etc. Es gelten weiterhin die folgenden Garantiebedingungen: ordnungsgemäße Installation, Pflege und Wartung.

HAARTROCKNERPFLEGE - Verlängerung der Lebensdauer

- Bitte befolgen Sie die entsprechenden Reinigungsanweisungen - Reinigen Sie den Lufteinlass alle 3 Monate oder wenn nötig und reinigen oder ersetzen Sie den Luftfilter nach Überprüfung alle 3 Monate (Black Mambo, Polarfox, Carbonic, AIR).
- Wickeln Sie das Kabel nicht um den Haartrockner.
- Verwenden Sie den Haartrockner nicht, um Kleidungsstücke oder etwas anderes als das Haar zu trocknen.
- Vorsicht vor einer möglichen „heißen“ Düse nach längerem Gebrauch. /

HAIR DRYER WARRANTY of 2 years does not apply for Spa applications or applications that may constitute continuous use – hair salons, etc. Other warranty conditions still apply: proper installation, care and maintenance.

HAIR DRYER CARE – Extend Life Span

- Please follow appropriate cleaning instructions – vacuum the air intake every 3 months or when necessary and cleaning or replacing the air filter after inspection every 3 months (Black Mambo, Polarfox, Carbonic, AIR).
- Do not coil the power cord or wrap it around the dryer.
- Do not use the hair dryer to assist in the drying of garments, shoes or anything other than hair.
- Beware of a possible “hot” nozzle after long usage.

Ihre Sicherheit . . . unser Anliegen / Your Safety . . . Our Concern

Normen und Verordnungen sind und waren für uns nie ein Ärgernis, sondern Teil einer zielgerichteten Konstruktion. Sie dienen der Sicherheit und Ihre Sicherheit ist unser Anliegen. So wurden praktisch alle Produkte von Aliseo so konstruiert, dass sie die Tarifnormen der europäischen Staatengemeinschaft CE erfüllen oder noch speziellere Normen übertreffen.

In keeping with our philosophy of safety, durability and functionality, regulations are never an annoyance for us but are rather guardrails of directed design. Regulations always have to do with safety. Your safety is our concern. Thus virtually all Aliseo products have been engineered to meet or exceed CE requirements as well as when necessary more specialized standards.

Sicherheitsabstände / Installation Safety Distances

Elektrische Anschlüsse müssen von Duschen und Badewannen mindestens 0,60 m (Zone 3) und von Brauseköpfen mindestens 1,20 m entfernt sein. /

Electric appliances must be wired to the electric circuit in a minimum distance of 0,60 m from shower cabins and bath tubs (zone 3) and of 1,20 m from shower heads.

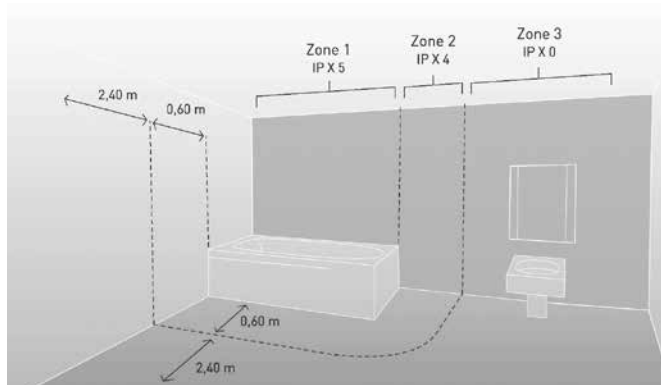

Was Sie über Haartrockner wissen sollten ! / What You Should Know About Hair Dryers !

FI-Schalter

Ein Schalter, der in praktisch alle Badezimmer-Stromkreise eingebaut wird und der das Risiko eines elektrischen Schlages eliminiert, da er sofort den Stromfluss zu allen elektrischen Geräten unterbricht. Seit Mitte der 1980er Jahre, ist der FI-Schalter in fast allen Ländern bei Neubau und Renovierung obligatorisch.

Überhitzungsschutz

Ein Bauteil, das Benutzer sowie Haartrockner schützt, indem es den Haartrockner im Fall einer Überhitzung vorübergehend ausschaltet.

Schutzklasse II - Doppelte Isolierung

Nur Haartrockner mit Schutzklasse 2 sind doppelt elektrisch isoliert und dürfen in Badezimmern installiert werden.

Hotel-Sicherheits-Tastschalter

Der Haartrockner läuft nur, wenn der Schalter gedrückt wird. Sobald man den Schalter loslässt, schaltet der Haartrockner sofort ab. Der Tastschalter bietet zusätzliche Sicherheit, wenn der Haartrockner versehentlich fallen gelassen oder nicht ausgeschaltet wird.

Netztrennschalter

Ein Ein-/Ausschalter an der Wandhalterung, der die gesamte Stromversorgung des Gerätes unterbricht. Eine Sicherheitsanforderung, die in bestimmten Ländern obligatorisch ist.

Schukosteckdose

Ein geerdeter Anschluss für Schutzkontaktstecker.

Rasiersteckdose

Diese Option ermöglicht den Anschluss eines elektrischen Rasierapparates oder das Aufladen eines Mobiltelefons. Bestimmte Haartrockner verfügen über einen Umschalter zum Betrieb bei unterschiedlichen Spannungen - 230 V und 115 V.

Montage in Schublade

Besonders geeignet zur Aufbewahrung in einer Schublade.

Direktanschluss

Der Stromanschluss erfolgt direkt in der Wandhalterung. Der Haartrockner wird fest installiert.

Anschluss an Steckdose

Der Haartrockner hat ein Kabel mit Stecker zum Anschluss an eine Steckdose.

FI Switch

A switch installed in the circuitry of virtually all bathrooms that eliminates the risk of electrocution by immediately shutting off the flow of electricity to all appliances. Since the mid 1980's, the FI switch is required in almost all countries in new construction and renovations.

Overheating Protection

A safety feature that protects the user (guests) and the hair dryer by temporarily shutting down the dryer in case of overheating.

Class II - Double Insulation

Only hair dryers with the Class II have double electrical isolation and can be installed in a bathroom. You can identify them by this symbol.

Hotel Safety Switch

The dryer is only activated when the button on the handle is pressed. As soon as the button is released, the dryer immediately shuts off. An added safety feature if accidentally dropped or left on.

Interrupter Switch

An on/off switch on the wall holder that can cut off all power to the unit. A safety feature which is required in many countries.

Schuko Socket

A grounded receptacle for a schuko plug.

Shaver Socket

An optional convenience that is available for shaver sockets or for telephone recharging units. Certain dryers have a built-in transformer that permits both 230 V and 115 V applications.

Drawer Storage

Designed expressly to fit in a drawer.

Hard Wire Application

The hair dryer is wired directly to the electrical source and is fixed with the holder.

Plug-in Application

The hair dryer comes with cord and plug for plug-in application.

KOSMETIKSPIEGEL

COSMETIC MIRRORS







Ambiente Hintergrundbeleuchtung /
Backside ambient lighting

LED MOON DANCE



THE ULTIMATE IN COSMETIC CARE

Mit „Moon Dance by Aliseo“ hat sieger design eine neue Dimension geschaffen: Die „mondartige“ Aura des Spiegels entsteht durch den transluzenten Acrylkörper, der sein Licht auf subtile Weise, ganzheitlich und in alle Richtungen, entfaltet. Feinste Materialien, minutiöse Oberflächenverarbeitung und eine solide Konstruktion geben Robustheit und Langlebigkeit.

Das lichtdurchlässige Gehäuse aus Acryl sorgt für unverwechselbare ambiente Hintergrundbeleuchtung. Elegante runde Formen, eine weiche Rückenkrümmung sowie eine fein strukturierte Oberfläche simulieren den nächtlichen Himmelskörper./

Developed exclusively for Aliseo by sieger design, the Moon Dance features clean defined lines, new materials and lighting methodologies creating an understated sculptural form of individualized taste and technological seduction. Translucent acrylic housing creates a distinctive backside ambient light.

Circular motif, soft dorsal curvature and smooth textured finish simulate the nocturnal celestial body.

LED MOON DANCE

SMD-LED-Beleuchtung
Warmweißes Licht, 3500-4000 K
Kühles weißes Licht, 5000-5500 K
3-fach-Vergrößerung
High-Tech-Tastschalter
Transluzenter Acryl-Rahmen
Kugelgelenk
Schutzklasse I
100-240 V
Direktanschluss
Messingkonstruktion

SMD-LED-lighting
Warm white light, 3500-4000 K
Cool white light, 5000-5500 K
3x magnification
Hi-tech touch control
Translucent acrylic frame
Full pivotal adjustment
Class I
100-240 V
Hard wire application
Brass construction

IP44



Standmodell
chrom, ø 240 mm /
Free standing
chrome, ø 240 mm

020759

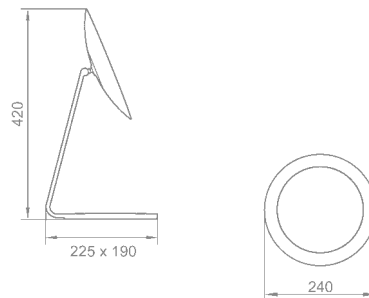

Am Schwenkarm
chrom, ø 240 mm /
On single arm
chrome, ø 240 mm

020758

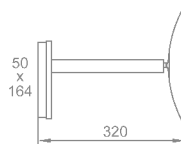

product concept + design: sieger design



LED MOON DANCE

Transluenter Acryl-Rahmen /
Translucent acrylic housing

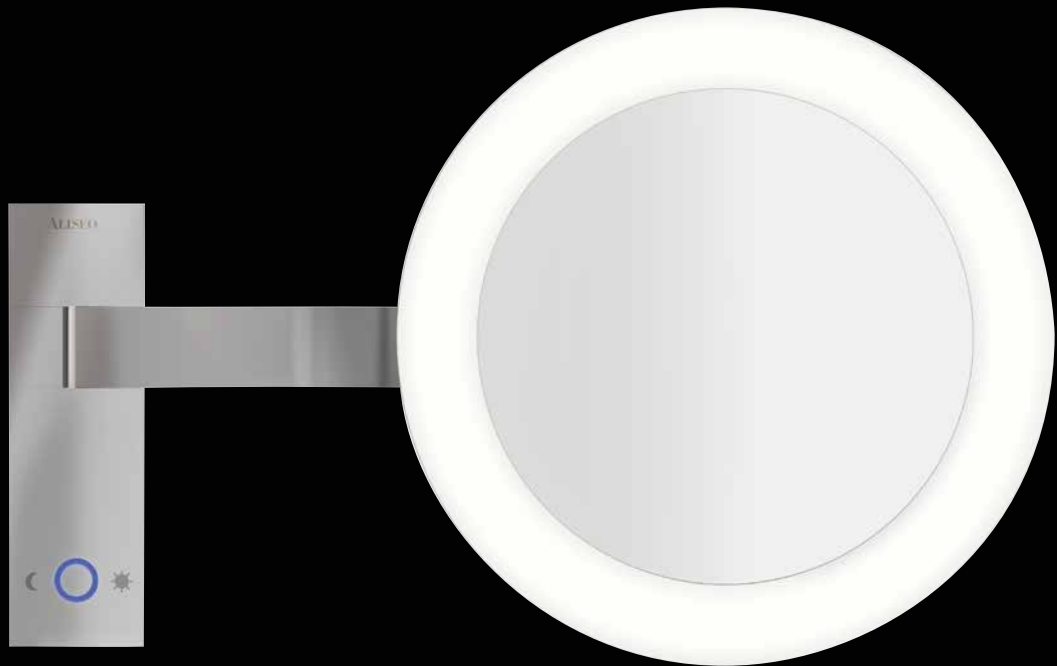

Tastschalter aktiviert wahlweise ein
warmweißes oder kühles weißes Licht /
Touch sensor offers the choice of a
warm white or cool white reflection





LED MOON DANCE

SMD-LED-Beleuchtung
 Warmweißes Licht, 3500-4000 K
 Kühles weißes Licht, 5000-5500 K
 3-fach-Vergrößerung
 High-Tech-Tastschalter
 Transluenter Acryl-Rahmen
 Kugelgelenk
 Schutzklasse I - Kontrollbox
 100-240 V
 Direktanschluss
 Messingkonstruktion

SMD-LED-lighting
 Warm white light, 3500-4000 K
 Cool white light, 5000-5500 K
 3x magnification
 Hi-tech touch control
 Translucent acrylic frame
 Full pivotal adjustment
 Class I - control box
 100-240 V
 Hard wire application
 Brass construction

IP44



Wandstange
 chrom, ø 240 mm /
 Wall bar
 chrome, ø 240 mm
020817

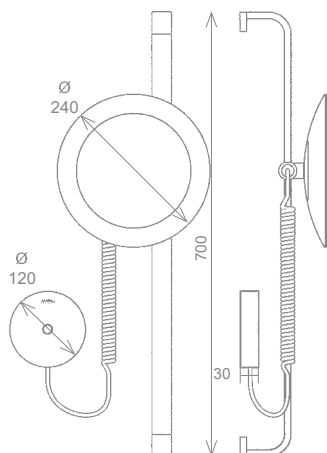

Transluenter Acryl-Rahmen /
 Translucent acrylic housing

T3 Kontrollbox /
 T3 Control Box





Die revolutionäre T³ Beleuchtung verwendet zwei LED Systeme mit spezifischer weißer/warmweißer Lichtfarbe. Der Gast hat die Option der Farbwahl. Elektrische Komponenten sind im Inneren des Lichtkreises angebracht, um eine schattenfreie Reflexion zu ermöglichen. (Standardausführung bei den Kosmetikspiegeln SATURN, CUBIK und MOON DANCE.) /

Revolutionary T³ lighting utilizes two independent SMD-LED systems with different light emitting pigmentations. Two-Tone-Touch lighting offers the user the choice of a shadow-free brighter daytime look or a warmer more polished night-time appearance. (Standard on SATURN, CUBIK and MOON DANCE mirrors.)

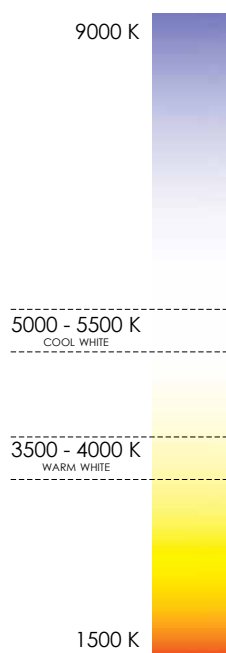

KELVIN FARBSPEKTRUM / KELVIN COLOR SPECTRUM

Da LEDs keine Wärme benötigen, um Licht zu erzeugen, wird deren Farbtemperatur anhand der Lichtfarbe errechnet.

Die Kosmetikspiegel CITY LIGHT, CUBIK LIMITED, VISION, LUNATEC, und LUNATEC MINIMALIST haben ein warmweißes Licht von 3500 bis 4000 Kelvin.

Aliseo's T³ Kosmetikspiegel SATURN, CUBIK und MOON DANCE haben zwei Farbtöne, ein warmweißes Licht von 3500 bis 4000 Kelvin und ein kühles weißes Licht von 5000 bis 5500 Kelvin. /

Because LEDs do not use heat to create light, their color temperature is estimated in relation to the color of the light.

Aliseo mirrors CITY LIGHT, CUBIK LIMITED, VISION, LUNATEC, and LUNATEC MINIMALIST have a warm white light of 3500 - 4000 Kelvins.

Aliseo T³ mirrors SATURN, CUBIK, MOON DANCE have dual tones a warm white light of 3500 - 4000 Kelvins and a cool white light of 5000 - 5500 Kelvins.

NEW MATERIALS & DESIGNS



Die SMD Platinen Technik hat es Aliseo's Designern ermöglicht, die minimalistischen und ultraflachen Spiegel zu entwickeln. Neue Materialien können nun eingesetzt werden und perfektionieren die unverwechselbare Ästhetik der jeweiligen Spiegel.

Individualisierung des Hotelbads mit Design, Materialien und Details

Bei „MOON DANCE“, von Star Designer Dieter Sieger konzipiert, ist das Highlight der aus transluzenten Acrylglas gefertigte Lichtkörper. Eine weitere Abwandlung der gleichen Lichtkonzeption, aber mit abgerundeten Kanten, ist das Modell Vision. Beide Modelle ließen sich erst durch den Einsatz von SMD Platinen erfolgreich realisieren.

* Alle Spiegel sind in verchromter Ausführung erhältlich. Je nach Menge und Ausführung sind Sonderanfertigungen möglich. /

SMD LED technology has created a new world of design possibilities that offer greater flexibility, aesthetic performance and design freedom.

The increased intensity of the light and extremely thin SMD lighting platform has enabled the usage of new materials and more advanced designs. Aliseo understands the integrity and relationship of different materials that combine clarity of purpose with utilitarian beauty.

Individualizing the Bathroom with Design, Materials and Detail

The Sieger designed MOON DANCE uses a molded translucent acrylic canopy that emits a distinctive backside ambient light while the VISION features distinctive transparent acrylic edge-lit imaging. Both are powered by flexible SMD-LED lighting strips.

* All mirrors available in chrome finish. Special custom finishes available depending on quantity and finish selected.



NU finishes





The **finish** completes the Design

Das NU-Finish-Sortiment ergänzt die hervorragende Handwerkskunst von Aliseo mit einer beeindruckenden Auswahl an Farben und Oberflächen. Ein perfekt integriertes persönliches Statement, das die koordinierte Transformation der Komponenten des Raumes als Ganzes vervollständigt.

Die PVD-Beschichtungstechnik erzeugt eine brillante, dekorative und dauerhafte Beschichtung, die einfach zu reinigen, kratzfest und korrosionsbeständig und mit fast jeder gewünschten Oberfläche kompatibel ist - matt, gebürstet oder poliert. /

NU finish assortment complements Aliseo's superlative craftsmanship with a commanding range of colors that conforms to the finish of choice. A perfectly integrated personal statement that completes the coordinated transformation of the components of the room as a whole. Aliseo utilizes PVD - a Physical Vapor Deposition high-tech process that produces a brilliant decorative and durable coating. Simple to clean and highly resistant to scratches, NU finishes are available in an almost endless variety of colors and surfaces - matt, brushed or polished and are compatible with virtually any provided designated finish.



Die NU-Oberflächen von Aliseo schaffen eine frische ästhetische Performance, die die unverwechselbare Persönlichkeit des Spiegels ausstrahlt und gleichzeitig die Auswahlmöglichkeiten für den Hotelier erweitert. Die Farbanpassung ist mit jeder vorgesehenen Oberfläche kompatibel.

Garantie auf die Oberfläche: 10 Jahre auf die Chromoberfläche, 5 Jahre auf die PVD-Oberfläche, 2 Jahre auf die Pulverbeschichtung - vorausgesetzt, die allgemeinen Aliseo-Pflegehinweise werden befolgt. /

Aliseo's NU finishes create a fresh aesthetic performance that radiates the distinctive personality of the mirror while expanding the choices available to the hotelier. Color match is compatible with any provided designated finish.

Warranty on Surface: 10 years Chrome Finish, 5 years on PVD Finish, 2 years on Powder Coating - provided general Aliseo maintenance guidelines are followed.



LED MOONDANCE
poliertes Messing / polished brass



LED INTERFACE
Nickel gebürstet / brushed nickel poliertes Messing / polished brass chrom / chrome



Something for Everyone

NU-Oberflächen sind in einer nahezu unbegrenzten Auswahl an Farben und Oberflächen erhältlich, die mit dem Metallmuster des gewünschten Armaturenherstellers übereinstimmen. Die Farbkoordinaten werden über ein 3-dimensionales Farbfotometer extrahiert. Die Werte werden nun berechnet, der Spiegel in eine Kammer gelegt und der PVD-Prozess beginnt. Die Farbanpassung ist mit jeder vorgesehenen Oberfläche kompatibel. /

NU colors are available in an almost endless variety of surface colors that conform to the metal swatch obtained from the desired faucet manufacturer.

Color coordinates are extracted via a 3 dimensional color photometer. The values are now calculated, the mirror placed in a chamber and the PVD process begins. Color match is compatible with any provided designated finish.

(Unten sehen Sie nur einen Querschnitt einiger unserer beliebtesten Oberflächen) /

(Below is just a cross-section of some of our most popular finishes)

POLIERT / POLISHED



CHROM 100 /
CHROME 100



BRONZE 201



GOLDOPTIK 203 /
GOLD OPTIC 203



MESSING 206 /
BRASS 206



BRONZE 201



ROTGOLD 209 /
RED GOLD 209



CHROM SCHWARZ 211 /
BLACK CHROME 211

GEBÜRSTET / BRUSHED



CHROM 302 /
CHROME 302



BRONZE 301



GOLDOPTIK 303 /
GOLD OPTIC 303



MESSING 306 /
BRASS 306



BRONZE 301



ROTGOLD 309 /
RED GOLD 309



CHROM SCHWARZ 311 /
BLACK CHROME 311

Farbunterschiede aufgrund des Druckverfahrens vorbehalten.

Bitte gehen Sie auf unseren Konfigurator auf der NU-Finish Seite für eine operative Visualisierung. /

Subject to color differences due to the printing process.

Please go do our configurator NU finish page for an operational visualization.

LED SATURN
rotgold / red gold



COSMO MINIMALIST
schwarz / black

ME & MY

Be Yourself

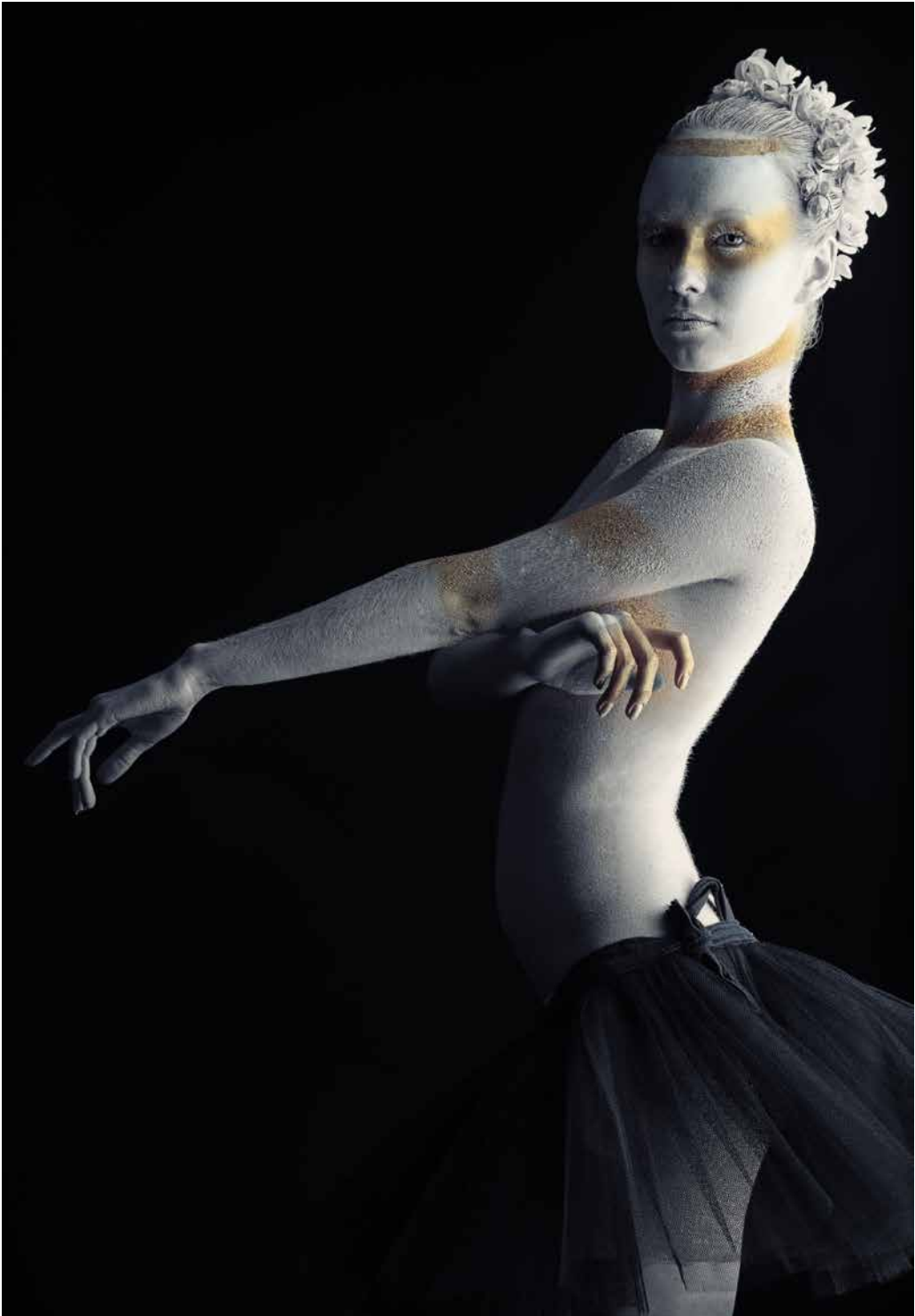



ME

Acryl-Hintergrundbeleuchtung
SMD-LED-Beleuchtung
Warmweißes Licht, 3500-4000 K
3-fach-Vergrößerung
Doppelwalzengelenk
Schutzklasse I
100-250 V
Direktanschluss

Acrylic - back light design
SMD-LED-lighting
Warm white light, 3500-4000 K
3x magnification
Multiple vertical, pivotal and
swing arm adjustment
Class I
100-250 V
Hard wire application



Am Schwenkarm
chrom, ø 220 mm /
On single arm
chrome, ø 220 mm
020835

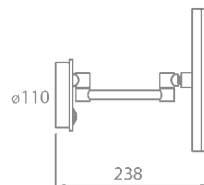

Am Doppel-Schwenkarm /
chrom, ø 220 mm
On twin arm
chrome, ø 220 mm
020836

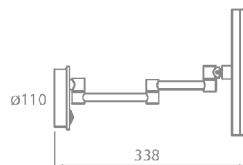

Green Efficiency



Mit Acryl-Hintergrundbeleuchtung / With acrylic-back light design



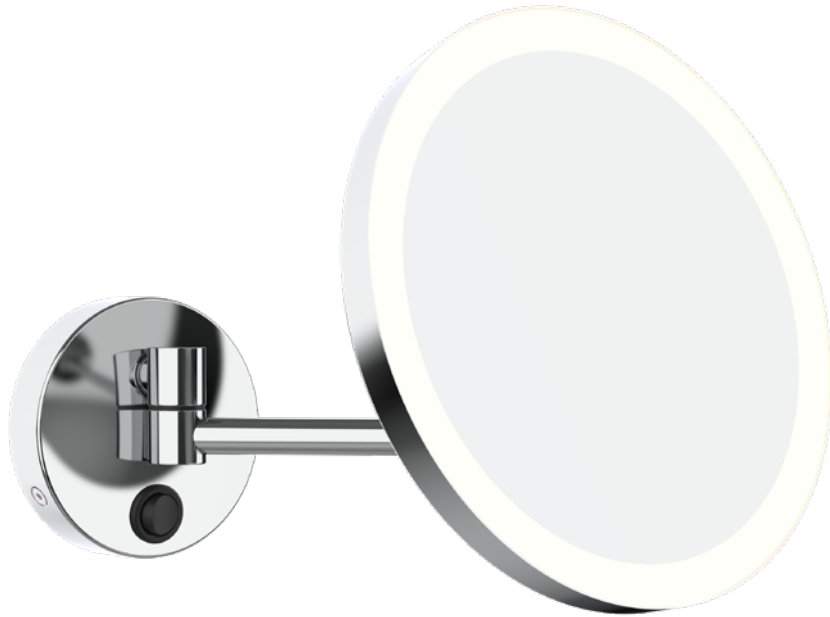

MY

SMD-LED-Beleuchtung
 Warmweißes Licht, 3500-4000 K
 3-fach-Vergrößerung
 Doppelwalzengelenk
 Schutzklasse I
 100-250 V
 Direktanschluss

SMD-LED-lighting
 Warm white light, 3500-4000 K
 3x magnification
 Multiple vertical, pivotal and
 swing arm adjustment
 Class I
 100-250 V
 Hard wire application



Am Schwenkarm
 chrom, ø 220 mm /
 On single arm
 chrome, ø 220 mm
020843

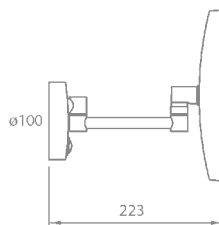

Am Doppel-Schwenkarm
 chrom, ø 220 mm /
 On twin arm
 chrome, ø 220 mm
020844

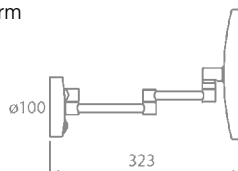



Maximale Einstellbarkeit in einem vollverchromten Gehäuse. /
Maximum adjustability in a full chrome housing.



Green Efficiency





THE MIRROR HAS TWO FACES

The Ultimate in Cosmetic Imaging

T3 Technology verwendet zwei LED Systeme mit spezifischer weißer/ warmweißer Lichtfarbe. Der Gast hat die Wahl zwischen Tages- oder Abendbeleuchtung. /

T3 Technology integrates two independent systems with different light reflective pigmentations offering the user their choice of a cool bright daytime look or a warm night time reflection.

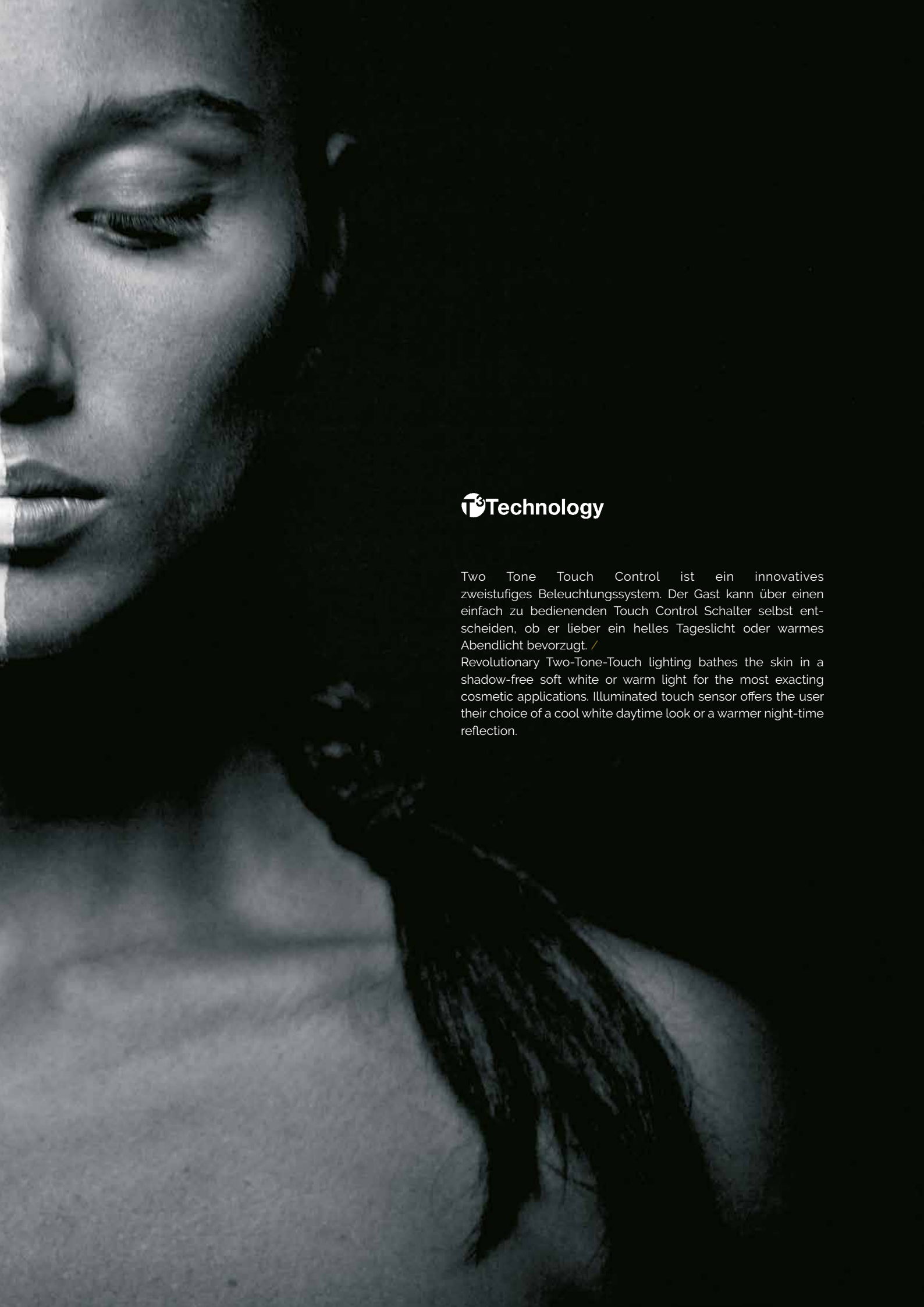

Technology

Two Tone Touch Control ist ein innovatives zweistufiges Beleuchtungssystem. Der Gast kann über einen einfach zu bedienenden Touch Control Schalter selbst entscheiden, ob er lieber ein helles Tageslicht oder warmes Abendlicht bevorzugt. /

Revolutionary Two-Tone-Touch lighting bathes the skin in a shadow-free soft white or warm light for the most exacting cosmetic applications. Illuminated touch sensor offers the user their choice of a cool white daytime look or a warmer night-time reflection.

LED SATURN



Beleuchteter Tastschalter /
Illuminated touch sensor

Perfekte Ausleuchtung
bis zu 50.000 h wartungsfreie Beleuchtung /
LED pin-point reflection
up to 50,000 hour maintenance free illumination

"The Mirror Has Two Faces"

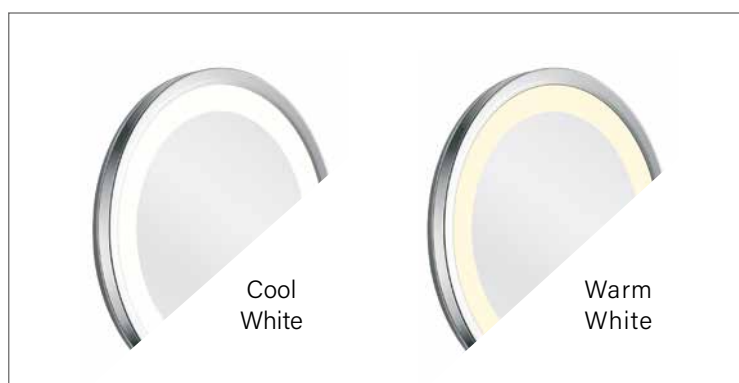

Green Efficiency



Technology
Two-Tone-Touch

Zwei unabhängige LED-Beleuchtungssysteme mit Tages- oder
Abendbeleuchtung /
Two independent LED systems with light reflective pigmentation



rotgold / red gold

LED SATURN

SMD-LED-Beleuchtung
 Warmweißes Licht, 3500-4000 K
 Kühles weißes Licht, 5000-5500 K
 3-fach-Vergrößerung
 High-Tech-Tastschalter
 Kugelgelenk
 Schutzklasse I
 100-240 V
 Direktanschluss
 Messingkonstruktion
 IP44



SMD-LED-lighting
 Warm white light, 3500-4000 K
 Cool white light, 5000-5500 K
 3x magnification
 Hi-tech touch control
 Full pivotal adjustment
 Class I
 100-240 V
 Hard wire application
 Brass construction

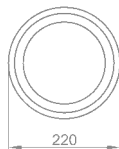

Am Schwenkarm
 chrom, ø 220 mm /
 On single arm
 chrome, ø 220 mm
020743

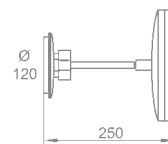

Am Doppel-Schwenkarm
 chrom, ø 220 mm /
 On Twin arm
 chrome, ø 220 mm
020744

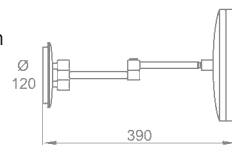





Stabiles Kugelgelenk für individuelle
Verstellbarkeit /
Reinforced ball joint for full pivotal
imaging

“A Modern Day Classic”

Perfekte Ausleuchtung
bis zu 50.000 h wartungsfreie Beleuchtung /
LED pin-point reflection
up to 50,000 hour maintenance free illumination



Green Efficiency



Technology
Two-Tone-Touch



chrom gebürstet /
brushed chrome

NU finishes

LED CUBIK

SMD-LED-Beleuchtung
Warmweißes Licht, 3500-4000 K
Kühles weißes Licht, 5000-5500 K
3-fach-Vergrößerung
High-Tech-Tastschalter
Kugelgelenk
Schutzklasse I
100-240 V
Direktanschluss
Messingkonstruktion
IP44



SMD-LED-lighting
Warm white light, 3500-4000 K
Cool white light, 5000-5500 K
3x magnification
Hi-tech touch control
Full pivotal adjustment
Class I
100-240 V
Hard wire application
Brass construction

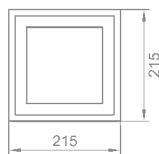

Am Schwenkarm
chrom, 215 x 215 mm /
On single arm
chrome, 215 x 215 mm

020745

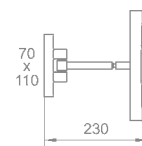

Am Doppel-Schwenkarm
chrom, 215 x 215 mm /
On twin arm
chrome, 215 x 215 mm

020746

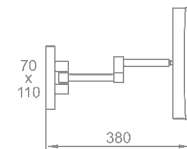

Standmodell
chrom, 215 x 215 mm /
Free standing
chrome, 215 x 215 mm

020747

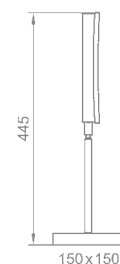

Wahlweise mit Tages- oder Abendbeleuchtung / Variable Day or Night time Illumination



Einzigartiger, beleuchteter Tastschalter /
Illuminated two-position touch sensor





COSMO CUBIK - Bold And Casual

Kompakte Formsprache mit Konzentration auf das Wesentliche. /
Compact sturdy physique with defined unpretentious lines.

Verstärktes Gelenk erhöht
Beständigkeit und Langlebigkeit /
Reinforced pivot pin adds
strength and durability



COSMO CUBIK

Plan- und
3-fach-Vergrößerung
Verdeckte Montageeinheit

Plain and
3x magnification
Covered backplate

Am verkürzten Doppel-Schwenkarm
chrom, 200 x 200 mm /
On shortened twin arm
chrome, 200 x 200 mm

020604

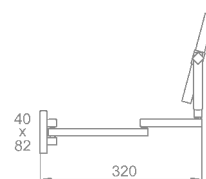
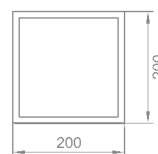

LED VISION

Wandhalterung mit integriertem
Tastschalter in schlanker Dreiecksform /
Low profile triangular wall bracket with
convenient integrated touch sensor



REFLECTION REDEFINED

Die puristische Schönheit dieses Spiegels entsteht durch die Harmonie seiner abgerundeten Kanten. Der transluzente Acrylring verstärkt die Lichtführung und prägt auf ganz besondere Weise das Gefühl von Anmut und zeitloser Eleganz. Die technische Raffinesse von Vision befindet sich in der selbstentwickelten SMD LED Beleuchtungsplatine, die leistungsstark und besonders energieeffizient ist. /

Gently curved profile framed by stunning edge-lit LED acrylics turns a room into a vibrant statement of personal taste. Aesthetic functionality at its finest; refined and durable twin-arm construction allows for a full range of motion and angular adjustments.

A re-imagination of a mirror reinvented.

Wartungsfreie Beleuchtung mit transluzenten Acrylring
mit abgerundeten Kanten /
Gently curved profile framed by unique acrylic-edge
LED lighting provides full maintenance-free illumination

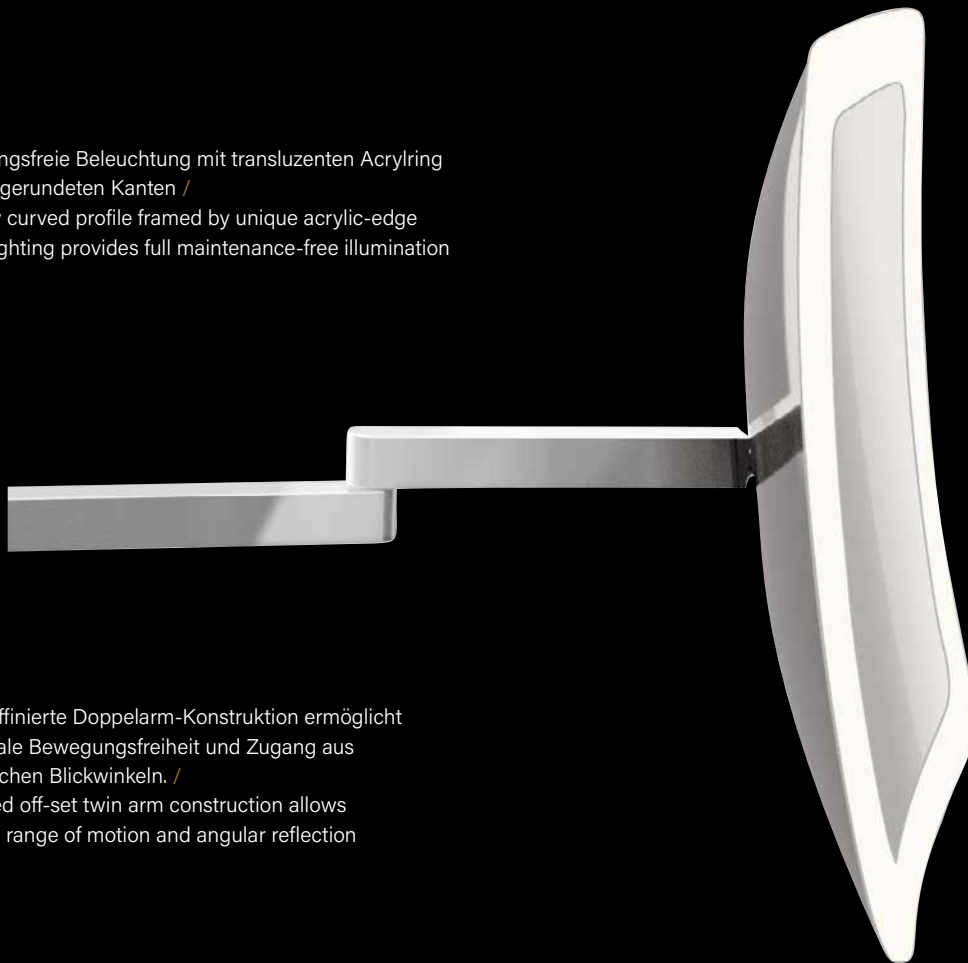

Die raffinierte Doppelarm-Konstruktion ermöglicht
optimale Bewegungsfreiheit und Zugang aus
sämtlichen Blickwinkeln. /
Refined off-set twin arm construction allows
for full range of motion and angular reflection



Green Efficiency

LED VISION

SMD-LED-Beleuchtung
Kühles weißes Licht, 5000-5500 K
3-fach-Vergrößerung
Kugelgelenk
High-Tech-Tastenschalter
Transluzenter Acryl-Rahmen
Schutzklasse I
100-240 V
Direktanschluss
Messing-Komponenten



SMD-LED-lighting
Cool white light, 5000-5500 K
3x magnification
Full pivotal adjustment
Hi-Tech touch control
Translucent acrylic frame
Class I
100-240 V
Hard wire application
Brass components

Am Doppel-Schwenkarm
chrom, 180 x 240 mm /
On Twin arm
chrome, 180 x 240 mm

020767

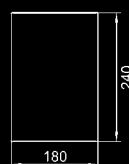
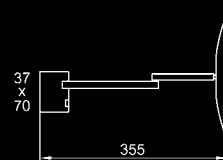

COSMO MINIMALIST



COSMO MINIMALIST

3-fach-Vergrößerung

Kugelgelenk

Standmodell

chrom, ø 200 mm /

3x magnification

Full pivotal adjustment

Free standing

chrome, ø 200 mm

020488

Leichte Ausrichtung /
Fingertip adjustment

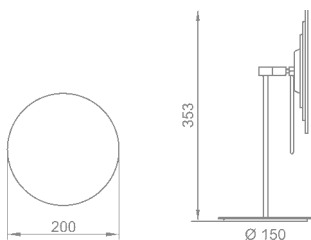



COSMO MINIMALIST

3-fach-Vergrößerung
Kippgelenk
Verdeckte Montageeinheit
Messing-Komponenten

3x magnification
Full pivotal adjustment
Covered backplate
Brass components

Am Schwenkarm
chrom, ø 200 mm /
On single arm
chrome, ø 200 mm
020607

Am Schwenkarm
pulverbeschichtet, schwarz matt
ø 200 mm /
On single arm
powder coating, black matt
ø 200 mm
020804

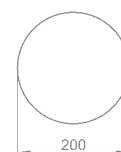
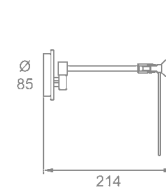



Ultra-schlankes, platzsparendes Design Flach an die Wand klappbar / Ultra slim space saving design Folds flat to the wall



FACE

3-fach-Vergrößerung
 Dreh-/ Kippgelenk
 Verdeckte Montageeinheit
 3x magnification
 Full pivotal adjustment
 Covered backplate

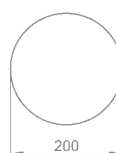

Am Schwenkarm
 chrom, ø 200 mm
 Adapterplatte für
 bessere Stabilität /
 On single arm
 chrome, ø 200 mm
 Adapter plate for
 improved stability

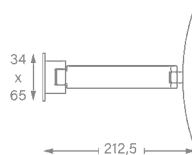

020831



Adapterplatte
 Adapter plate

Am Doppel-Schwenkarm
 chrom, ø 200 mm
 Adapterplatte für
 bessere Stabilität /
 On twin arm
 chrome, ø 200 mm
 Adapter plate for
 improved stability

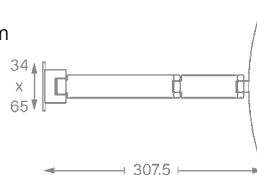

Adapterplatte
 Adapter plate

020829



Höhenverstellbar. Flach an die Wand klappbar / Height adjustable. Folds flat to the wall



FACE plus

3-fach-Vergrößerung
 Höhenverstellbar mit
 Schwenkeinstellungen
 Schwenkarm an die Wand klappbar
 Verdeckte Montageeinheit
 Verdeckte Schrauben

3x magnification
 Height adjustable with
 pivotal adjustments
 Swivel arm folds to the wall
 Covered mounting bracket
 Concealed screws

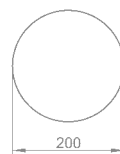

Am Schwenkarm
 Montage rechts
 chrom, ø 200 mm /
 On single arm
 right mounting
 chrome, ø 200 mm

020834

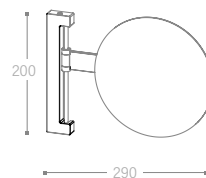

Am Schwenkarm
 Montage links
 chrom, ø 200 mm /
 On single arm
 left mounting
 chrome, ø 200 mm

020837

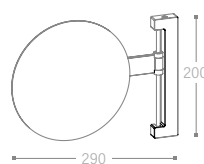

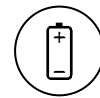

batteriebetrieben /
battery powered

Batteriebetrieben, 4 x AA
Akkubatterie oder Trocken-
batterie mit Anzeige bei
schwacher Batterie
Leicht zugängliches Batterie-
fach mit Schnappschloss /
Powered by 4 x AA dry or
rechargeable batteries complete
with a low power indicator
Easily accessible snap-cover
battery compartment





INTERFACE - Look & See

Automatisches Einschalten durch Gesichtsannäherung
 Ein Infrarot-Sensor aktiviert die automatische Ein-/Ausschaltung
 der LED-Beleuchtung im transluzenten Acrylrings
 im Abstand von 20 cm /

Lights automatically as your face approaches
 Auto ON/OFF infrared sensor activates a translucent
 acrylic edge LED lighting system.
 Operational up to 20 cm.



Sensor



batteriebetrieben /
 battery powered



automatische Ausschaltfunktion
 nach 15 Sek. / automatic switch
 -off after 15 sec.

LED INTERFACE



A Much Appreciated Affordable Upgrade

INTERFACE zeichnet sich durch ein elegantes effizientes minimalistisches Design mit integrierter vertikaler Einstellung aus. Die transluzente Acryl-LED-Beleuchtung strahlt mit einem warmen, natürlichen, bernsteinfarbenen Schimmer. /

INTERFACE features an elegantly efficient minimalist design with an integrated vertical slot adjustment. Translucent acrylic LED lighting emits a warm natural amber glow.



Sensor



batteriebetrieben /
battery powered



automatische Ausschaltfunktion
nach 15 Sek. / automatic switch
-off after 15 sec.

LED INTERFACE

SMD-LED-Beleuchtung
Warmweißes Licht, 3500-4000 K
3-fach-Vergrößerung
Verstärktes Dreh-/Kippgelenk
Batteriebetrieben
Messing-Komponenten

SMD-LED-lighting
Warm white light, 3500-4000 K
3x magnification
Sturdy reinforced pivot joint
Battery powered
Brass components

Standspiegel
chrom, ø 220 mm /
Freestanding
chrome, ø 220 mm
020797

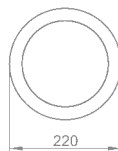
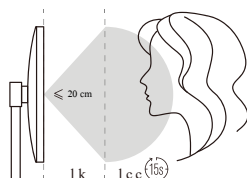
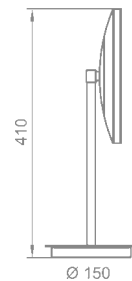

Am Schwenkarm
chrom, ø 220 mm
Adapterplatte für
bessere Stabilität /
On single arm
chrome, ø 220 mm
Adapter plate for
improved stability
020832

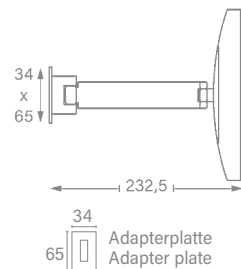



LED CITY LIGHT

SMD-LED-Beleuchtung
 Warmweißes Licht, 3500-4000 K
 3-fach-Vergrößerung
 Doppelwalzengelenk
 Schutzklasse I
 120-240 V
 Direktanschluss

SMD-LED-lighting
 Warm white light, 3500-4000 K
 3x magnification
 Full pivotal adjustment
 Class I
 120-240 V
 Hard wire application



Am Doppel-Schwenkarm
 chrom, ø 250 mm /
 On twin arm
 chrome, ø 250 mm
020657

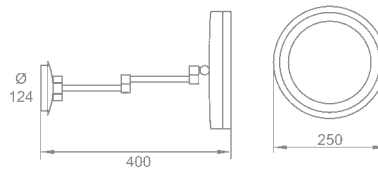

Am Schwenkarm
 chrom, ø 250 mm /
 On single arm
 chrome, ø 250 mm
020677

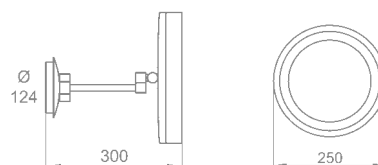



"Lighting The Way"

Großzügiger 25 cm Durchmesser / Generous 25 cm diameter

Perfekte Ausleuchtung bis zu 50.000 h wartungsfreie Beleuchtung /
LED pin-point reflection up to 50,000 hour maintenance free illumination



Green Efficiency





LED LUNATEC

SMD-LED-Beleuchtung
 Warmweißes Licht, 3500-4000 K
 3-fach-Vergrößerung
 Doppelwalzengelenk
 Schutzklasse I
 100-240 V
 Direktanschluss
 Messing-Komponenten
 ▶ 110 V auf Anfrage

SMD-LED-lighting
 Warm white light, 3500-4000 K
 3x magnification
 Full pivotal adjustment
 Class I
 100-240 V
 Hard wire application
 Brass components
 ▶ 110 V upon request

Am Schwenkarm
 chrom, ø 240 mm /
 On single arm
 chrome, ø 240 mm
020600

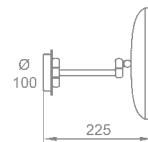

Am Doppel-Schwenkarm
 chrom, ø 240 mm /
 On twin arm
 chrome, ø 240 mm
020601

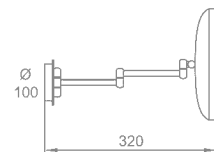

IP44





"Contemporary And Efficient"



Perfekte Ausleuchtung
bis zu 50.000 h wartungsfreie
Beleuchtung /
LED pin-point reflection
up to 50,000 hour maintenance
free illumination

Space Saving - Multiflex Fold-Away Design



CONCIERGE COLLECTION A Clear First Impression

Ein wartungsfreies, klassisches Sortiment,
das sich perfekt in jedes Ambiente
integrieren lässt. /

A serviceable assortment designed
to enhance the mood of any
space.

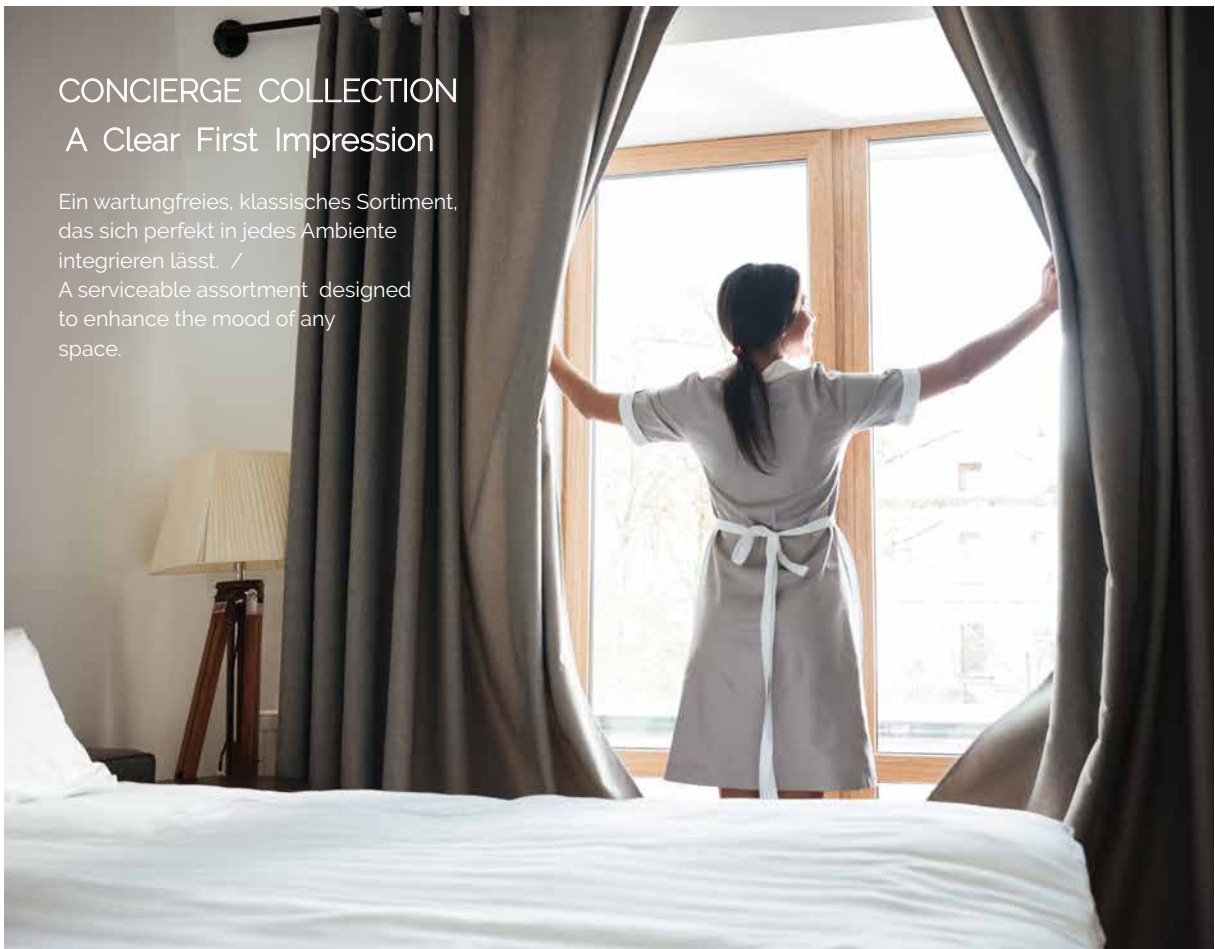

Höhenverstellbar /
Height adjustable



Plan- und 3-fach-Vergrößerung
Höhenverstellbar
Verdeckte Montageeinheit
Messing-Komponenten
Am Schwenkarm
chrom, ø 200 mm /
Plain and 3x magnification
Height adjustable
Covered backplate
Brass components
On single arm
chrome, ø 200 mm

020597

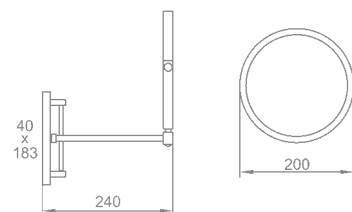

Plan- und 3-fach-Vergrößerung
 Verdeckte Montageeinheit
 Messing-Komponenten
 Am Schwenkarm
 chrom, ø 200 mm /
 Plain and 3x magnification
 Covered backplate
 Brass components
 On single arm
 chrome, ø 200 mm
020506

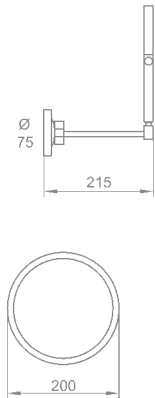

SICHERE BEFESTIGUNG
 ■ Separate Montageeinheit
 ■ Maximale Stabilität
 ■ Perfekt in Funktion und Design /
SECURE MOUNTING
 ■ Separate mounting bracket
 ■ Maximum stability
 ■ A finished elegant appearance

Am Doppel-Schwenkarm
 chrom, ø 200 mm /
 On twin arm
 chrome, ø 200 mm
020507

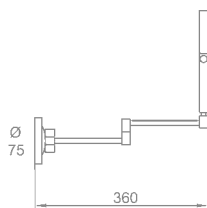



Modellübersicht / Product Overview

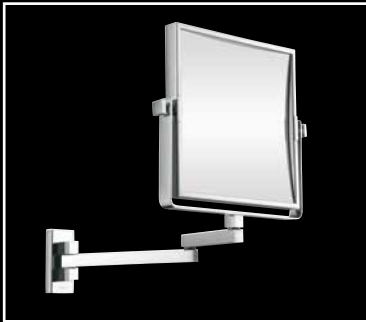

020604 COSMO CUBIK

200 x 200 mm. Ausgestreckt 320 mm
200 x 200 mm. Extends to 320 mm

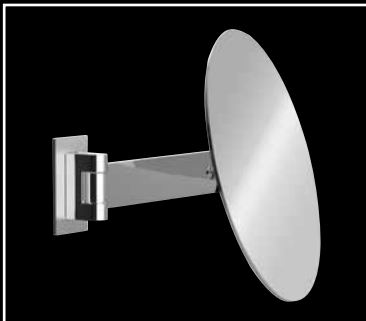

020831 FACE

ø 200 mm. Ausgestreckt 212,5 mm
ø 200 mm. Extends to 212,5 mm

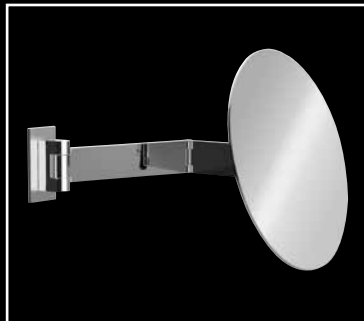

020829 FACE

ø 200 mm. Ausgestreckt 307,5 mm
ø 200 mm. Extends to 307,5 mm

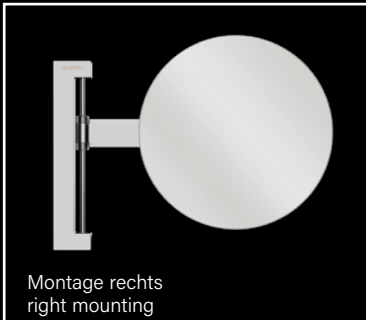

Montage rechts
right mounting

020834 FACE plus

ø 200 mm. Ausgestreckt 290 mm
ø 200 mm. Extends to 290 mm

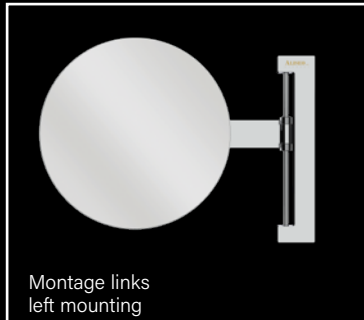

Montage links
left mounting

020837 FACE plus

ø 200 mm. Ausgestreckt 290 mm
ø 200 mm. Extends to 290mm



Modellübersicht / Product Overview

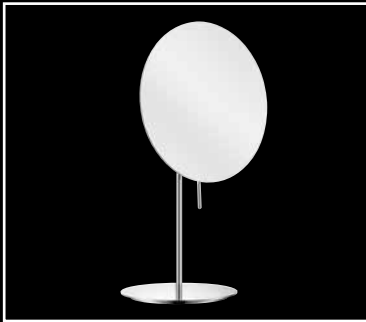

020488 COSMO MINIMALIST
ø 200 mm. Höhe 353 mm
ø 200 mm. Height 353 mm

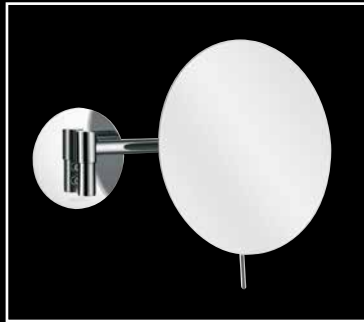

020607 COSMO MINIMALIST
ø 200 mm. Ausgestreckt 214 mm
ø 200 mm. Extends to 214 mm

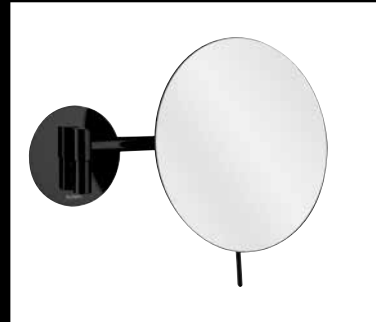

020804 COSMO MINIMALIST
ø 200 mm. Ausgestreckt 214 mm
ø 200 mm. Extends to 214 mm



020506 CONCIERGE
ø 200 mm. Ausgestreckt 215 mm
ø 200 mm. Extends to 215 mm



020507 CONCIERGE
ø 200 mm. Ausgestreckt 360 mm
ø 200 mm. Extends to 360 mm



020597 CONCIERGE
ø 200 mm. Ausgestreckt 240 mm
ø 200 mm. Extends to 240 mm

Alle Spiegel in verchromter Oberfläche.
Erhältlich in anderen Ausführungen. /
All mirrors in chrome finish.
Available in other finishes.



Modellübersicht / Product Overview



020758 LED MOON DANCE
ø 240 mm. Ausgestreckt 320 mm
ø 240 mm. Extends to 320 mm



020759 LED MOON DANCE
ø 240 mm. Höhe 420 mm
ø 240 mm. Height 420 mm



020817 LED MOON DANCE
ø 240 mm. Höhe 700 mm
ø 240 mm. Height 700 mm



020743 LED SATURN
ø 220 mm. Ausgestreckt 250 mm
ø 220 mm. Extends to 250 mm



020744 LED SATURN
ø 220 mm. Ausgestreckt 390 mm
ø 220 mm. Extends to 390 mm

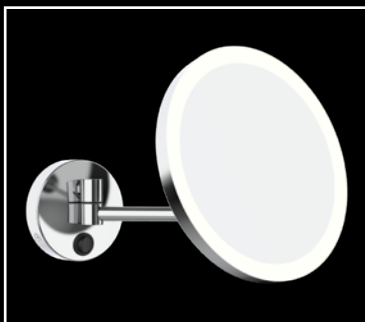

020843 MY
ø 220 mm. Ausgestreckt 223 mm
ø 220 mm. Extends to 223 mm

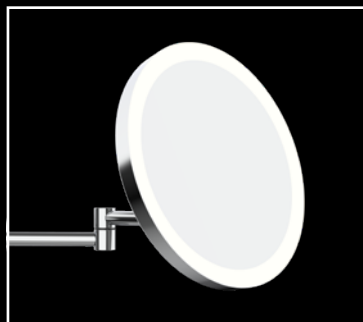

020844 MY
ø 220 mm. Ausgestreckt 323 mm
ø 220 mm. Extends to 323 mm

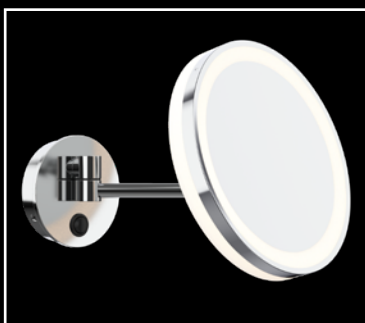

020835 ME
ø 220 mm. Ausgestreckt 238 mm
ø 220 mm. Extends to 238 mm

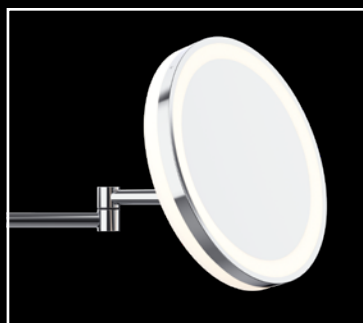

020836 ME
ø 220 mm. Ausgestreckt 338 mm
ø 220 mm. Extends to 338 mm

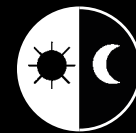

Technology
Two-Tone-Touch

Two Tone Touch Control ist ein innovatives zweistufiges Beleuchtungssystem. Der Gast kann über einen einfach zu bedienenden Tastschalter selbst entscheiden, ob er lieber ein helles Tageslicht oder warmes Abendlicht bevorzugt. / Two-Tone-Touch lighting bathes the skin in a shadow-free soft white or warm light for the most exacting cosmetic applications. Illuminated touch sensor offers the user their choice of a cool white daytime look or a warmer night-time reflection.



Modellübersicht / Product Overview



020745 LED CUBIK
215 x 215 mm. Ausgestreckt 230 mm
215 x 215 mm. Extends to 230 mm



020746 LED CUBIK
215 x 215 mm. Ausgestreckt 380 mm
215 x 215 mm. Extends to 380 mm



020747 LED CUBIK
215 x 215 mm. Höhe 445 mm
215 x 215 mm. Height 445 mm

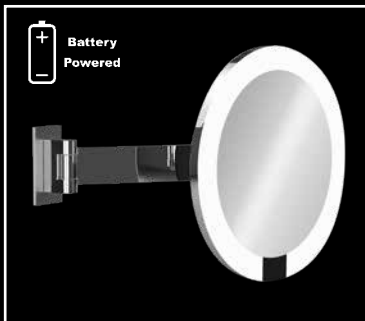

020832 LED INTERFACE
ø 220 mm. Ausgestreckt 232,5 mm
ø 220 mm. Extends to 232,5 mm



020797 LED INTERFACE
ø 220 mm. Höhe 410 mm
ø 220 mm. Height 410 mm



020767 LED VISION
180 x 240 mm. Ausgestreckt 355 mm
180 x 240 mm. Extends to 355 mm

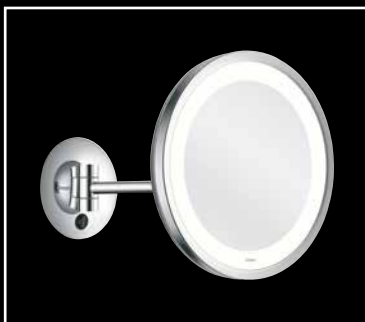

020677 LED CITY LIGHT
ø 250 mm. Ausgestreckt 300 mm
ø 250 mm. Extends to 300 mm



020657 LED CITY LIGHT
ø 250 mm. Ausgestreckt 400 mm
ø 250 mm. Extends to 400 mm



020600 LED LUNATEC
ø 240 mm. Ausgestreckt 225 mm
ø 240 mm. Extends to 225 mm



020601 LED LUNATEC
ø 240 mm. Ausgestreckt 320 mm
ø 240 mm. Extends to 320 mm

Alle Spiegel in verchromter Oberfläche.
Erhältlich in anderen Ausführungen. /
All mirrors in chrome finish.
Available in other finishes.

ALISEO BATHROOM ACCESSORIES

DIFFERENT BATHROOMS ... DIFFERENT LOOKS

Aliseo's Badezimmer-Accessoires lassen sich individuell auf Ihre Badplanung abstimmen: die moderne NOW, die kraftvolle Architecto, die zeitlose Tecno und die einzigartige NEXXUS

* Abweichende Ausführungen und Oberflächen lieferbar, abhängig von Modifikation und Stückzahl. /

Aliseo's accessories offer a visual stability and luxurious balance that complement the many different looks in bathroom décor: the contemporary NOW, the more defined Architecto, the timeless Tecno, and the unique NEXXUS.

* Different finishes and treatments available depending on finish selection and quantity.



NU-Oberflächen bieten eine nahezu unbegrenzte Auswahl an Farben – gebürstet oder poliert – und sind mit praktisch jeder zur Verfügung gestellten Oberflächenbehandlung kompatibel / NU finishes are available in an almost endless choice of colors – matt, brushed or polished – and are compatible with virtually any provided designated finish

Sofern nicht anders angegeben, sind ALISEO Hotelbad-Accessoires aus Messing hergestellt. Alle Messing-Produkte mit verchromter Oberfläche unterliegen einer 10-jährigen Garantie, vorausgesetzt, dass sie richtig installiert wurden und die Pflegeanleitung befolgt wird.

PVD-Oberflächen unterliegen einer 5-jährigen Garantie, die NEXXUS-Linie, die eine pulverbeschichtete Oberfläche hat, unterliegt einer 2-jährigen Garantie. /

Unless otherwise stated all ALISEO accessories are manufactured from brass. All brass constructed items with chrome finish are warranted for 10 years providing proper installation and maintenance instructions are followed.

PVD surfaces are covered by a 5-year warranty, the NEXXUS line which has a powdered coated finish is warranted for 2 years.



Architecto

Tecno

NOW

ALISEO BATHSTYLES

NEXXUS

Hocker / Stools

Complementary

Abfallbehälter / Waste bins

Waagen / Scales



Something for Everyone

NU-Oberflächen sind in einer nahezu unbegrenzten Auswahl an Farben und Oberflächen erhältlich, die mit dem Metallmuster des gewünschten Armaturenherstellers übereinstimmen. Die Farbkordinaten werden über ein 3-dimensionales Farbfotometer extrahiert. Die Werte werden nun berechnet, der Spiegel in eine Kammer gelegt und der PVD-Prozess beginnt. Die Farbanpassung ist mit jeder vorgesehenen Oberfläche kompatibel.

(Unten sehen Sie nur einen Querschnitt einiger unserer beliebtesten Oberflächen) /

NU colors are available in an almost endless variety of surface colors that conform to the metal swatch obtained from the desired faucet manufacturer.

Color coordinates are extracted via a 3 dimensional color photometer. The values are now calculated, the mirror placed in a chamber and the PVD process begins. Color match is compatible with any provided designated finish.

(Below is just a cross-section of some of our most popular finishes)

POLIERT / POLISHED



CHROM 100 /
CHROME 100



BRONZE 201



GOLDOPTIK 203 /
GOLD OPTIC 203



MESSING 206 /
BRASS 206



BRONZE 201



ROTGOLD 209 /
RED GOLD 209



CHROM SCHWARZ 211 /
BLACK CHROME 211

GEBÜRSTET / BRUSHED



CHROM 302 /
CHROME 302



BRONZE 301



GOLDOPTIK 303 /
GOLD OPTIC 303



MESSING 306 /
BRASS 306



BRONZE 301



ROTGOLD 309 /
RED GOLD 309



CHROM SCHWARZ 311 /
BLACK CHROME 311

Farbunterschiede aufgrund des Druckverfahrens vorbehalten.

Bitte gehen Sie auf unseren Konfigurator auf der NU-Finish Seite für eine operative Visualisierung. /

Subject to color differences due to the printing process.

Please go do our configurator NU finish page for an operational visualization.

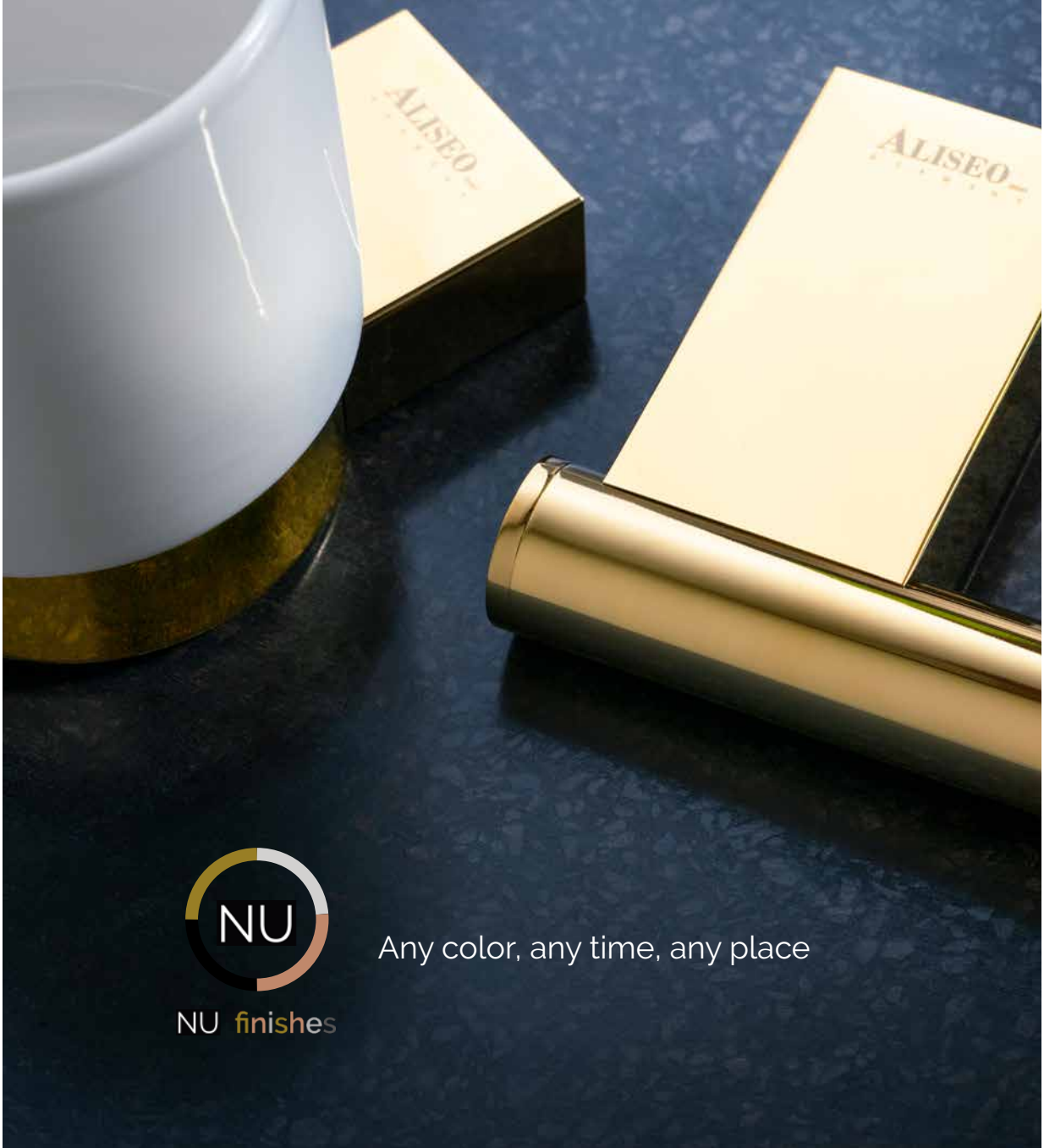

NU finishes

Any color, any time, any place

ARCHITECTO





770018
Sicherheits-Haltegriff /
Safety Grab Bar

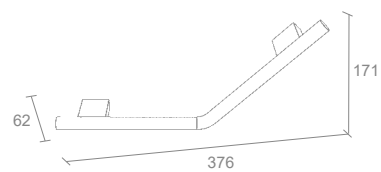



770005
Haken /
Hook

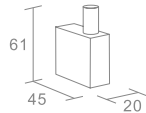

770011
Seifenhalter
Keramikschale /
Soap Dish
Ceramic Dish

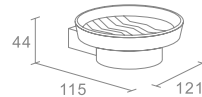

770012
Seifenspender
Keramik /
Soap Dispenser
Ceramic

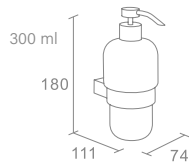

770009
Becherhalter
Keramikbecher /
Tumbler Holder
Ceramic Tumbler

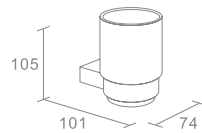

770016
Handtuchhalter /
Towel Rail

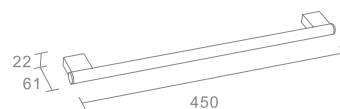



770006
Papierrollenhalter /
Toilet Roll Holder

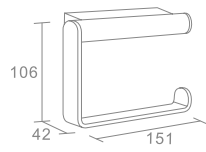

770007
Reserverollenhalter /
Spare Roll Holder

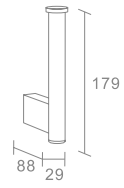

770017
Papierrollenhalter /
Toilet Roll Holder

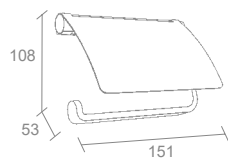

770008
WC-Bürstengarnitur
Keramikbehälter /
Toilet Brush Holder
Ceramic Case

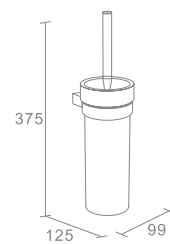





TECNO



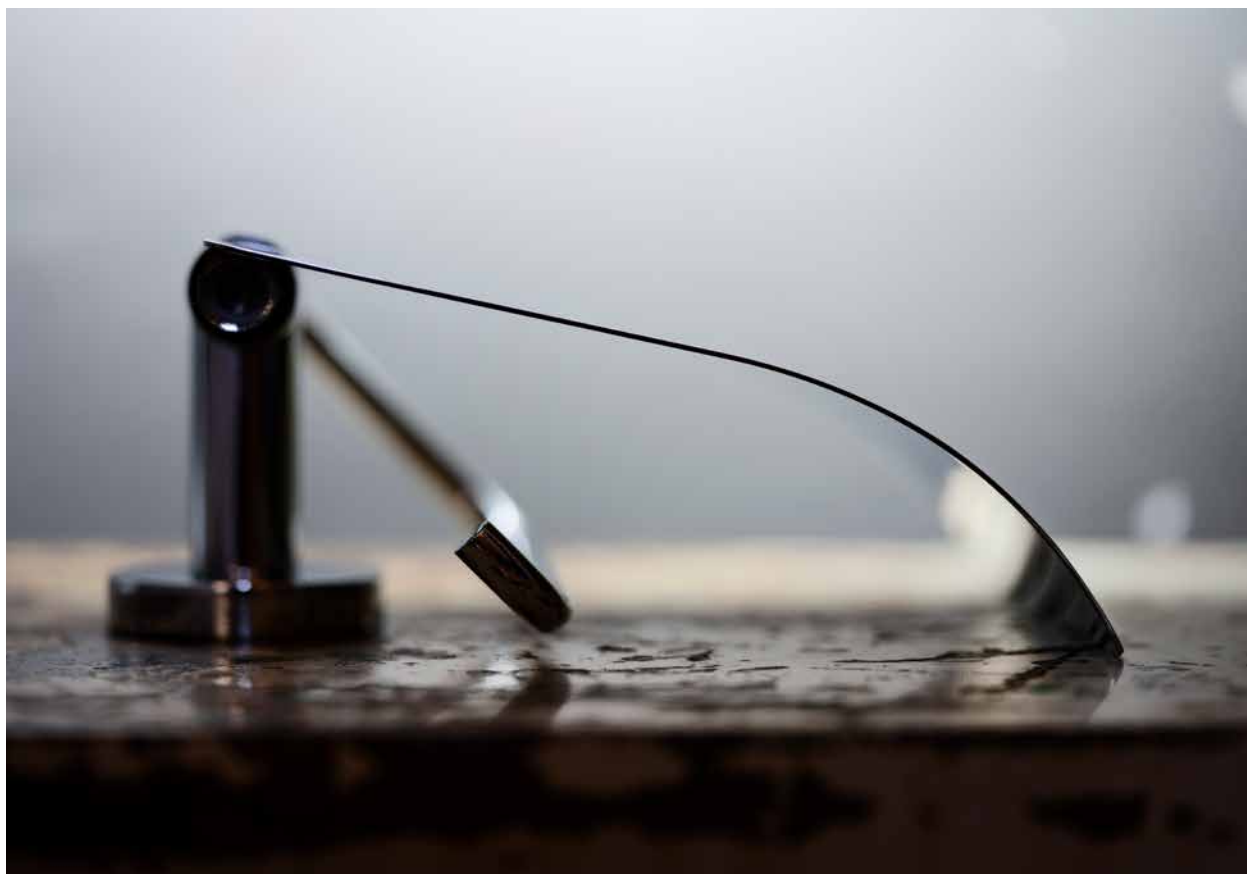

710013
Papierrollenhalter /
Toilet Roll Holder

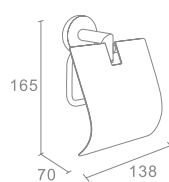



710008
 Papierrollenhalter /
 Toilet Roll Holder

710061
 Ausführung links /
 Left hand mount

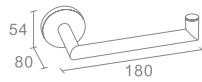

710009
 Reserverollenhalter /
 Spare Roll Holder

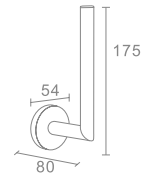

710014
 Doppel-Haken /
 Double Hook

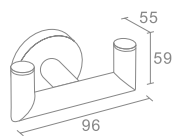

710006
 Haken /
 Hook

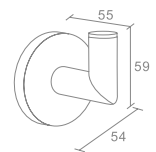

WC-Bürstengarnitur /
Toilet Brush Holder

030633
Standmodell /
freestanding

030707
Wandmontage /
Wall mounted

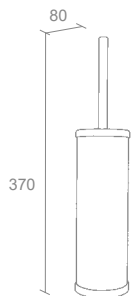



710010
 WC-Bürstengarnitur
 Satiniertes Glas /
 Toilet Brush Holder
 Iced Glass

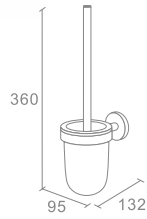



Sicherheits-Haltegriff /
Safety Grab Bar

710053/ 710054

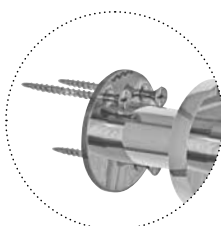
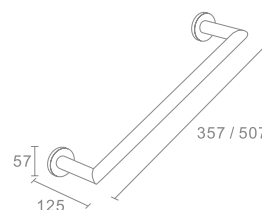

**FORMVOLLENDETE STÄRKE,
SICHERHEIT UND STABILITÄT**

- 3-Punkt-Befestigung
- Zugbelastung bis zu 190 kg
je nach Wandbauart /

**STYLISH STRENGTH, SAFETY
AND STABILITY**

- Positive 3 point fixation system
- Up to 190 kilo pull-weight capacity
depending on wall construction



710056

Sicherheits-Haltegriff mit Seifenkörbchen
Wechselseitige Montage /

Safety Grab Bar with Soap Basket
Adjusts to left and right hand installations

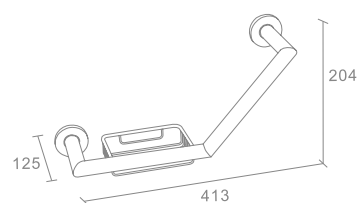



710059
Handtuchablage /
Towel Rack

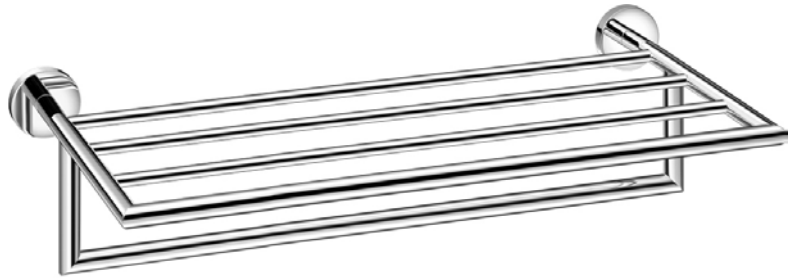
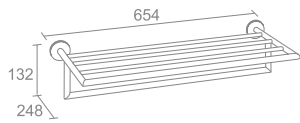

Handtuchhalter /
Towel Rail

710003/ 710052

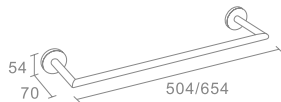

N O W





740006
 Papierrollenhalter /
 Toilet Roll Holder

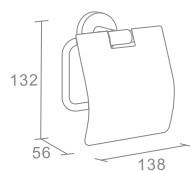

740007
 Papierrollenhalter /
 Toilet Roll Holder

740066
 Ausführung links /
 Left hand mount

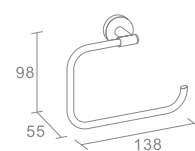



740017
Reserverollenhalter /
Spare Roll Holder

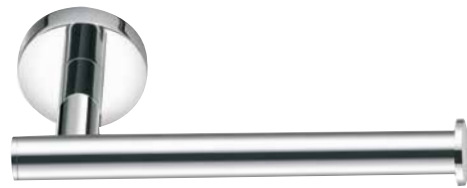
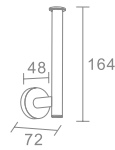

740008
Papierrollenhalter /
Toilet Roll Holder

740065
Ausführung links /
Left hand mount

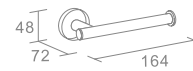

740009
WC-Bürstengarnitur
Satinieretes Glas /
Toilet Brush Holder
Iced Glass

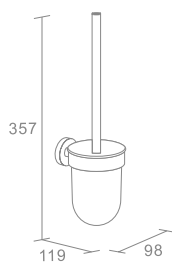

740018
WC-Bürstengarnitur. Standmodell
Edelstahl verchromt /
Toilet Brush Holder. Free standing
Stainless steel, chrome finish

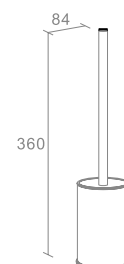

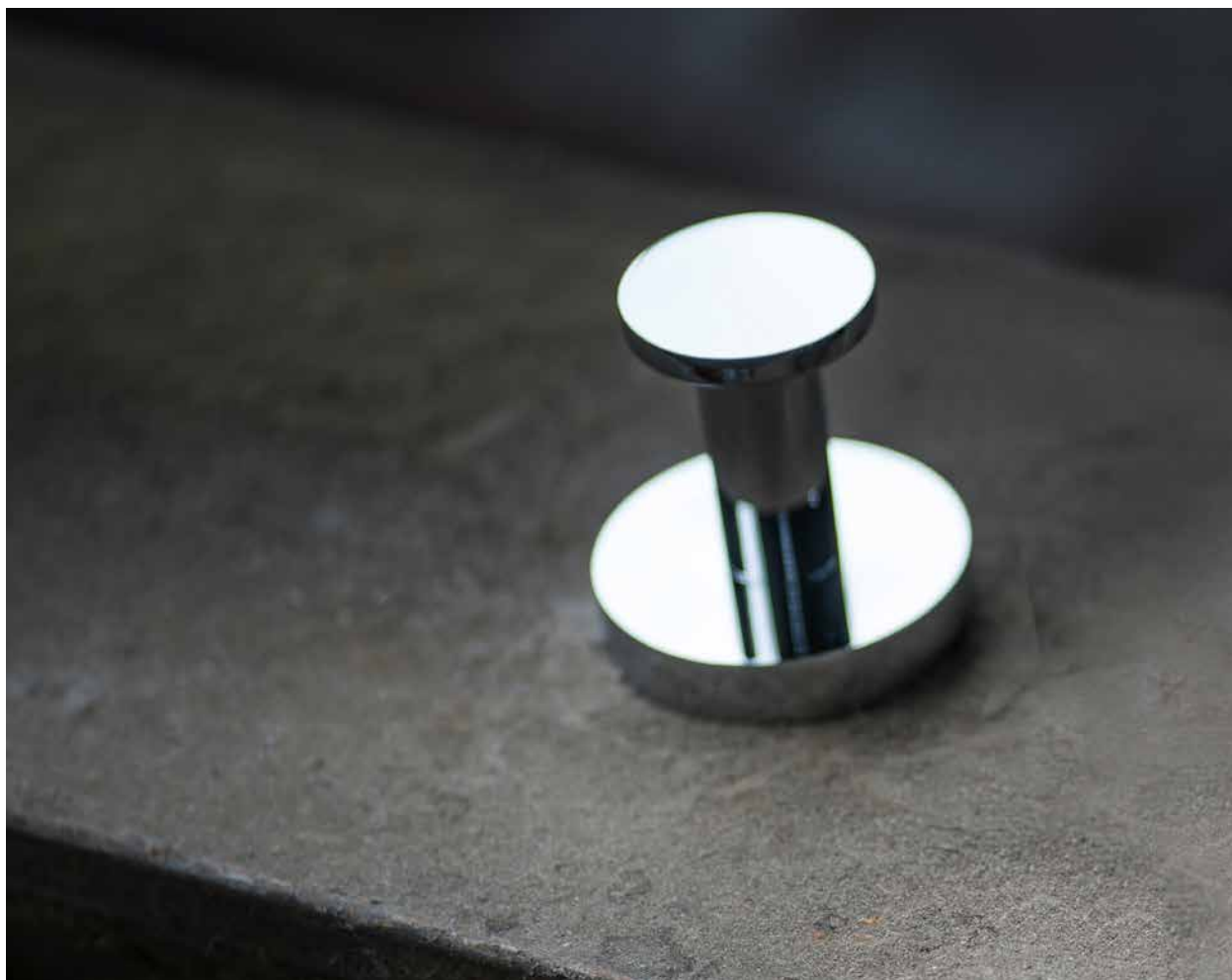

740004
Doppel-Haken /
Double Hook

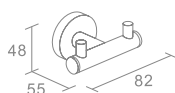

740016
Haken /
Hook

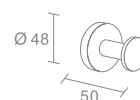



740010
 Glashalter
 Satiniertes Glas /
 Glass Holder
 Iced Glass

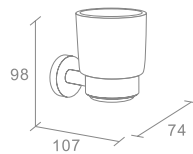

030615
 Seifenspender MOON
 Satiniertes Glas /
 Soap Dispenser MOON
 Iced Glass

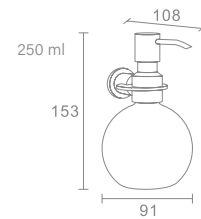

**Nicht für Duschanwendungen /
 Not for shower applications

740001
 Handtuchablage /
 Towel Rack



Handtuchhalter /
 Towel Rail

740002



740013



NEXXUS





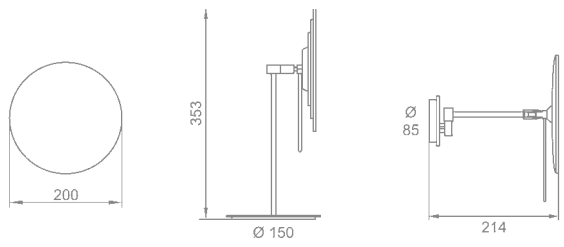

COSMO MINIMALIST

020805 Standmodell / Free standing
020804 Schwenkarm / Single arm
 3-fach-Vergrößerung / 3x magnification



740053
 Seifenhalter
 Satiniertes Glas /
 Soap Dish
 Iced Glass

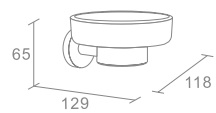

740052
 Glashalter
 Satiniertes Glas /
 Glass Holder
 Iced Glass

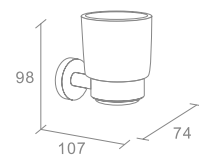

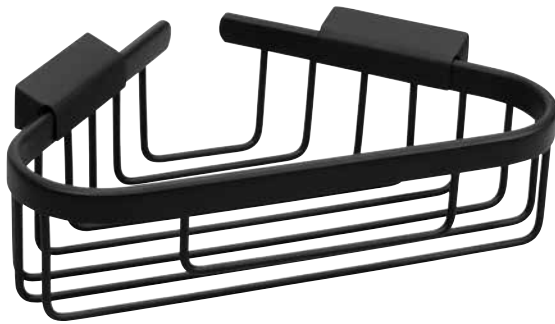

030706

Eckseifenkörbchen /
Corner Soap basket

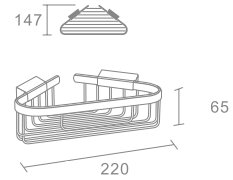

740050
Doppel-Haken /
Double Hook

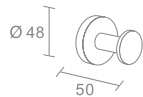

740045
Haken /
Hook

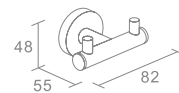



020801
LED CITY LIGHT
 SMD-LED-Beleuchtung
 3-fach-Vergrößerung
 Doppel-Schwenkarm /
 SMD-LED-lighting
 3x magnification
 Twin Arm

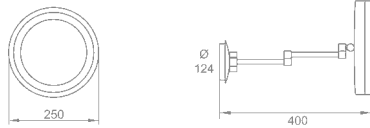

020802
CONCIERGE
 Plan- und 3-fach-Vergrößerung
 Doppel-Schwenkarm /
 Plain and 3x magnification
 Twin arm

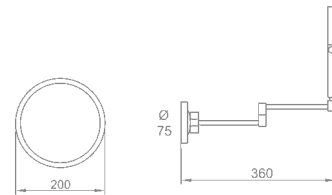

740047/ 740054

Handtuchhalter /
 Towel Rail





740038
Papierrollenhalter /
Toilet Roll Holder

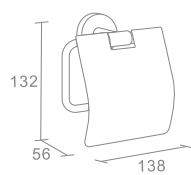

740042
Papierrollenhalter /
Toilet Roll Holder

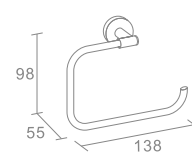

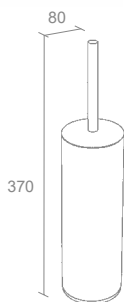

030708
WC-Bürstengarnitur
Wandmontage /
Toilet Brush Holder
Wall Mounted

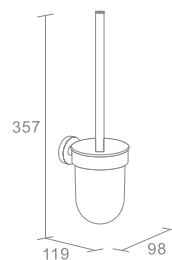

740044
WC-Bürstengarnitur
Satinieretes Glas /
Toilet Brush Holder
Iced Glass



740046
Reserverollenhalter /
Spare Roll Holder

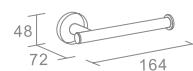

740043
Papierrollenhalter /
Toilet Roll Holder



030662

Hygienebaghalter
Kunststoff /
Sanitary Bag Dispenser
Plastic

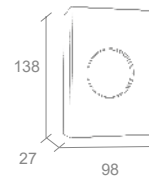

030661

Kosmetiktuchspender
Kunststoff /
Tissue Dispenser
Plastic

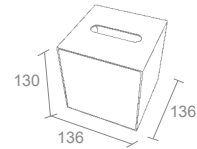

190052

LONDONER NOIR
Kosmetiktuchspender.
mit magnetischer Bodenklappe
Kunstleder /
Tissue Dispenser
with magnetic trap at the bottom
Faux leather

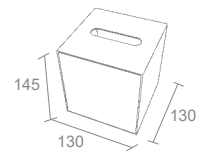

030710

Einbau- Kosmetiktuchspender
Einbaumaße: 264 x 130 x 76 mm
Messing /
Built-in Tissue Dispenser
Built-in dimensions: 264 x 130 x 76 mm
Brass

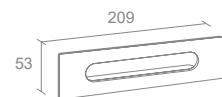

190078

LONDONER NOIR
Kosmetiktuchspender.
mit magnetischer Bodenklappe
Kunstleder /
Tissue Dispenser.
with magnetic trap at the bottom
Faux leather

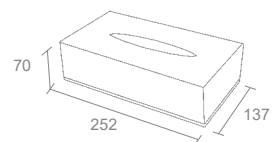



PRESTIGE
 Hygieneeimer
 Herausnehmbarer
 Kunststoffeinsatz
 Edelstahl. Schwarz /
 Step Bin
 Removable plastic
 inner bin
 Stainless steel. Black

030692
 3 L

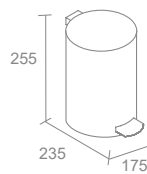

030691
 5 L

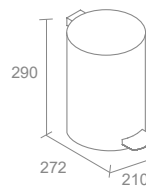

190094
LONDONER NOIR
 Abfallbehälter, 10 L
 Kunstleder /
 Waste Bin , 10 L
 Faux leather

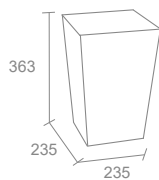

190055
LONDONER NOIR
 Abfallbehälter, 9 L
 Kunstleder /
 Waste Bin, 9 L
 Faux leather

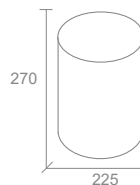

030627
 Abfallbehälter - 13 L
 Feuerfest. Abnehmbarer Deckel
 Metall /
 Waste Bin - 13 L
 Fire-proof. Removable top
 Metal

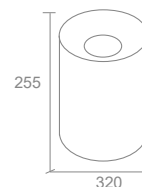

○ 115
 Deckelöffnung /
 Opening in the top

MAXIMA





MAXIMA

Ein starkes, modernes Design, das maximale Stärke und funktionelle Schönheit vereint.
Verdeckte Schrauben. Material: Zamak mit Pulverbeschichtung /

A bold contemporary design that combines maximum strength and utilitarian beauty.
Covered screws. Material: Zamak with powder coating

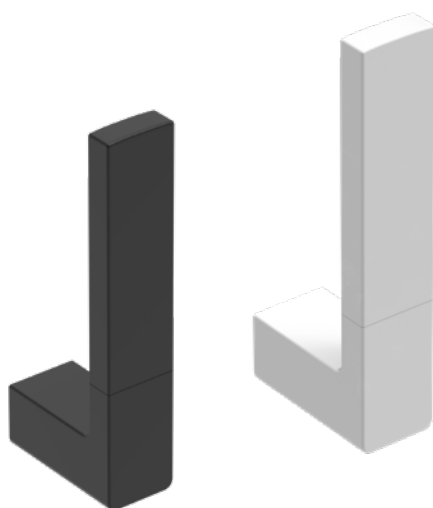

793004 - schwarz / black matt
794004 - weiß / white matt

Reserverollenhalter /
Spare Roll Holder

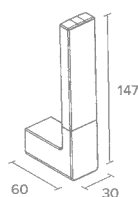

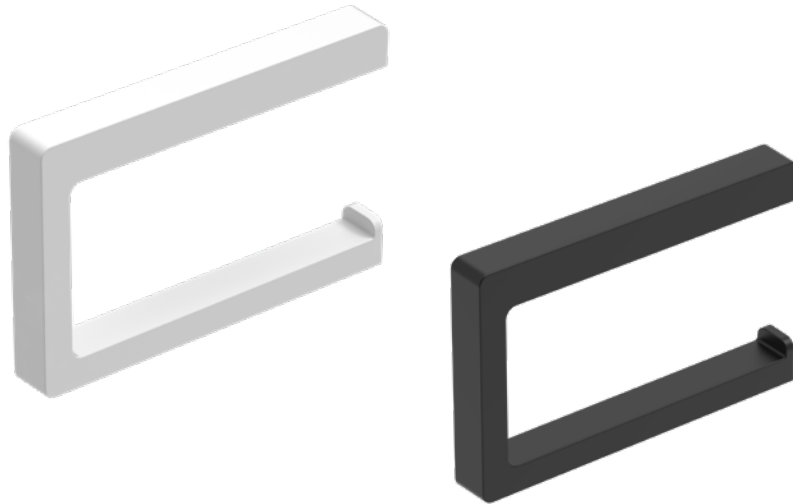

793003 - schwarz / black matt
794003 - weiß / white matt
Papierrollenhalter /
Toilet Roll Holder

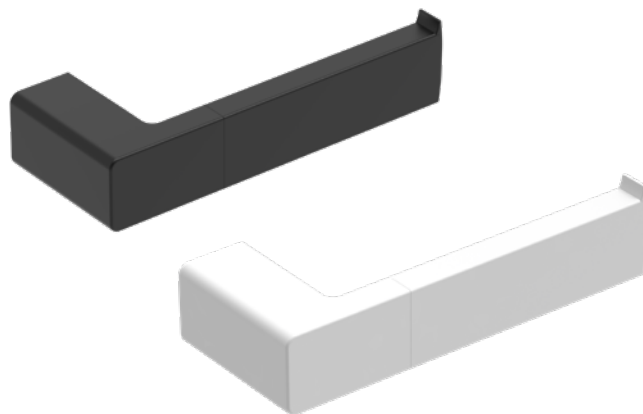
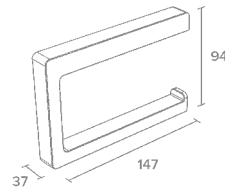

793002 -- schwarz / black matt
794002 - weiß / white matt
Papierrollenhalter /
Toilet Roll Holder

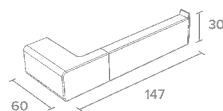



MAXIMA

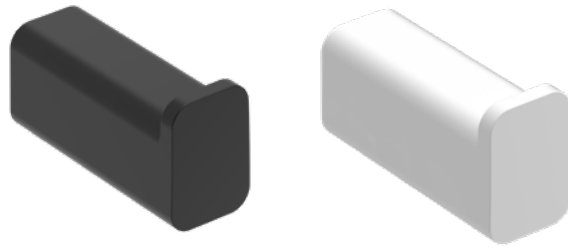

793001 - schwarz / black matt
794001 - weiß / white matt

Haken /
Hook

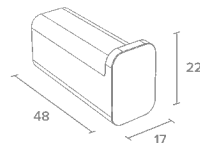

030672 - schwarz / black matt
030674 - weiß / white matt

WC-Bürstengarnitur
Wandmontage oder Standmodell
Herausnehmbarer Kunststoffeinsatz /
Toilet Brush Holder
Wall mounted or free standing model
Removable plastic insert

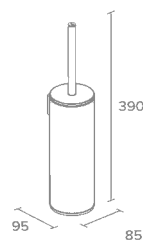

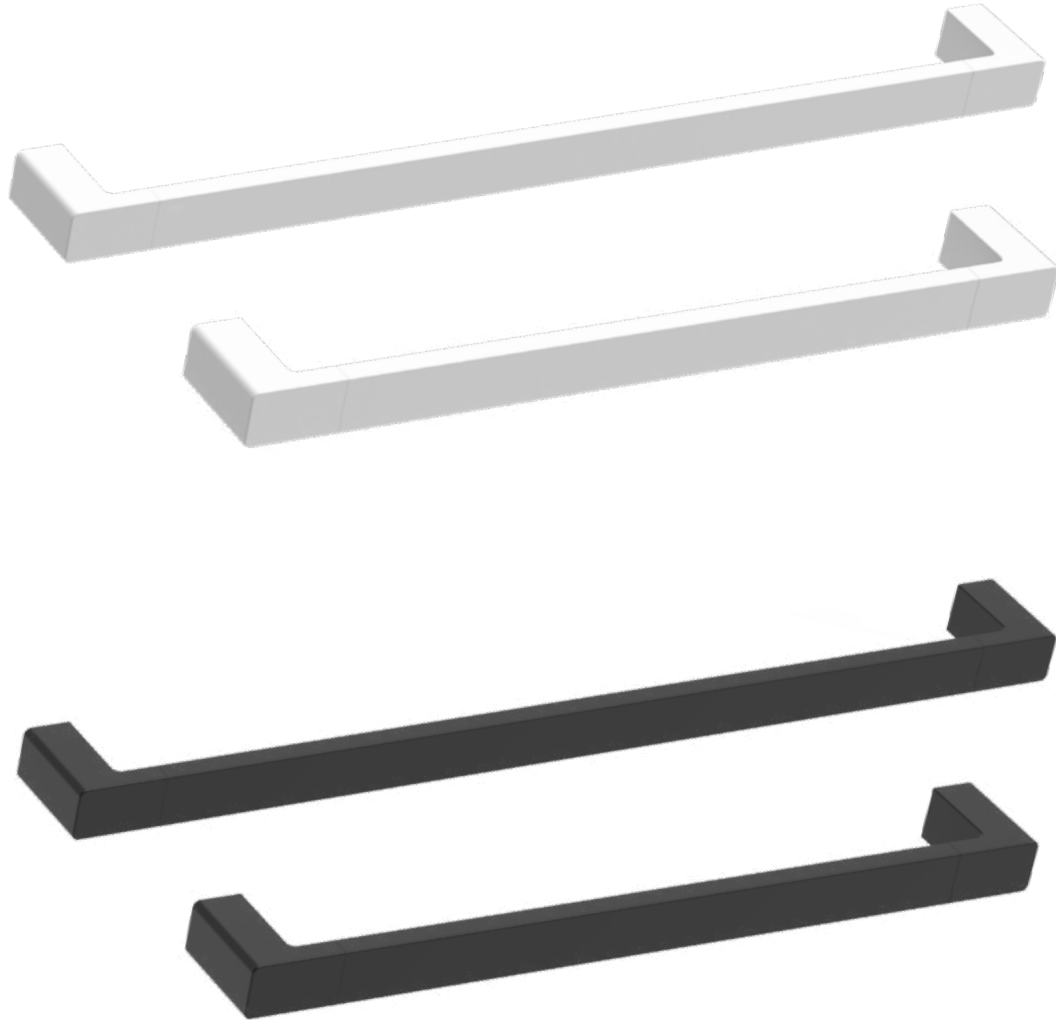

793005 - schwarz / black matt
794005 - weiß / white matt

Handtuchhalter /
 Towel Rail

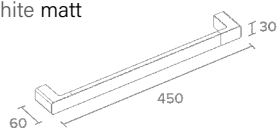

793006 - schwarz / black matt
794006 - weiß / white matt

Handtuchhalter /
 Towel Rail

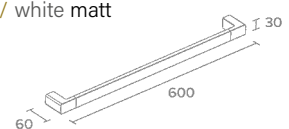



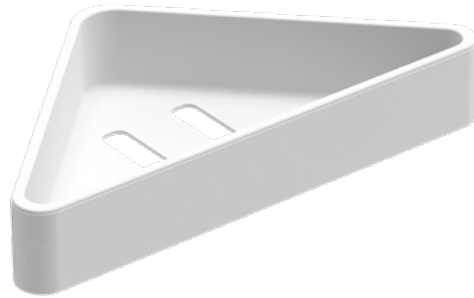
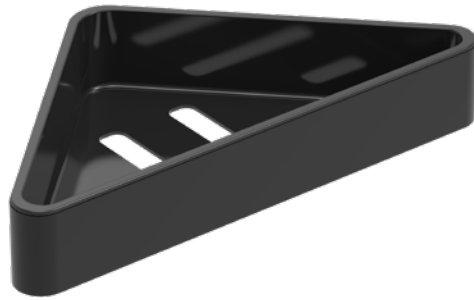

033677 - schwarz / black
034677 - weiß / white

Seifenkörbchen
Edelstahl mit matter
Pulverbeschichtung
Herausnehmbarer ABS-
Kunststoffeinsatz /
Corner Soap basket
Stainless steel with
matt powder coating
Removable, ABS plastic insert

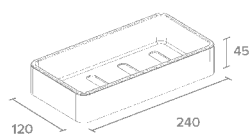

033671 - schwarz / black
034671 - weiß / white

Eckseifenkörbchen
Edelstahl mit matter
Pulverbeschichtung
Herausnehmbarer ABS-
Kunststoffeinsatz /
Corner Soap basket
Stainless steel with
matt powder coating
Removable, ABS plastic insert

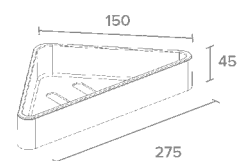



ARCHITECTO



770016

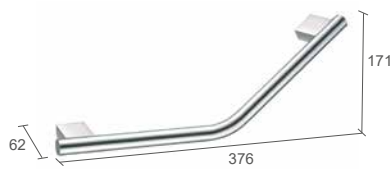

770018

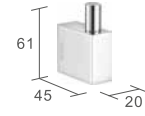

770005



770009



770012

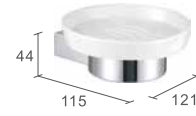

770011

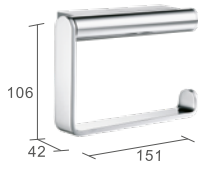

770006

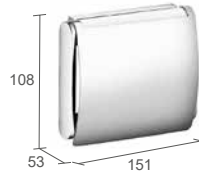

770017

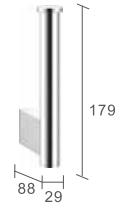

770007



770008



MAXIMA

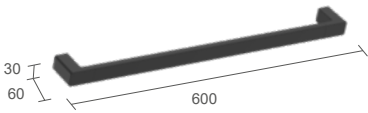

793006 - schwarz / black matt
794006 - weiß / white matt



793005 - schwarz / black matt
794005 - weiß / white matt

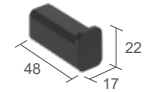

793001 - schwarz / black matt
794001 - weiß / white matt

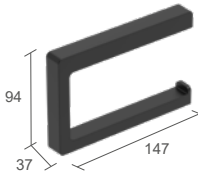

793003 - schwarz / black matt
794003 - weiß / white matt

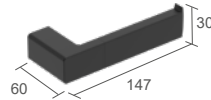

793002 - schwarz / black matt
794002 - weiß / white matt

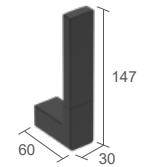

793004 - schwarz / black matt
794004 - weiß / white matt

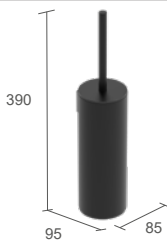

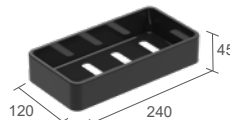

030672 - schwarz / black matt
030674 - weiß / white matt

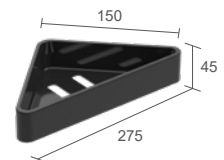

033677 - schwarz / black matt
034677 - weiß / white matt

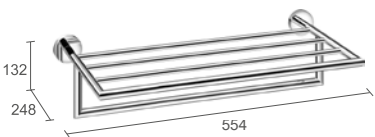
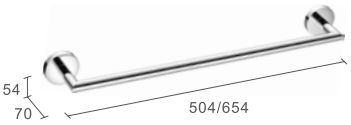
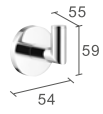
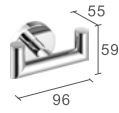
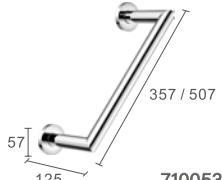
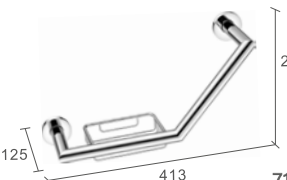
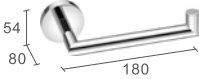
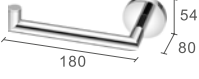
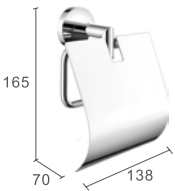
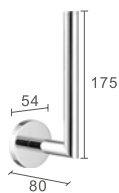

033671 - schwarz / black matt
034671 - weiß / white matt

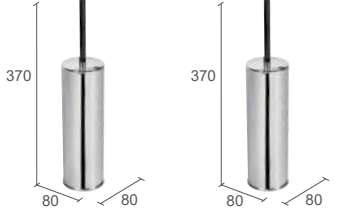
 <p>710059</p>	 <p>710003 710052</p>	 <p>710006</p>
 <p>710014</p>	 <p>710053 710054</p>	 <p>710056</p>
 <p>710008</p>	 <p>710061</p>	 <p>710013</p>
 <p>710009</p>	 <p>710010</p>	 <p>Free standing Freistehend 030633</p> <p>Wall mounted Wandmontage 030707</p>



NOW

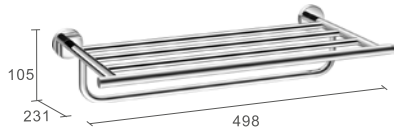

740001



740002 740013



030615

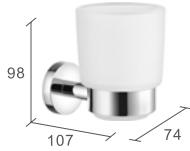

740010

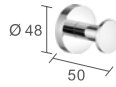

740016

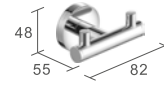

740004

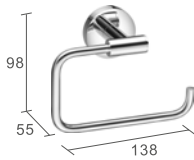

740007

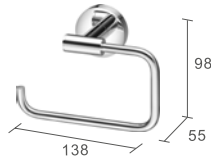

740066

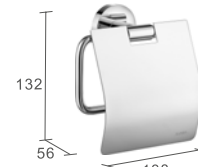

740006

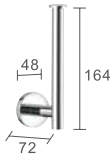

740017

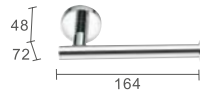

740008

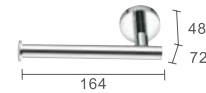











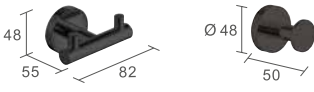
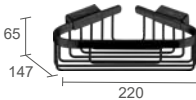

740065

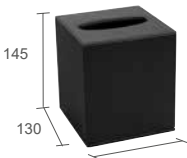
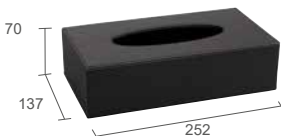
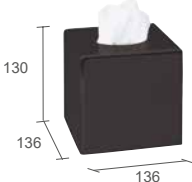

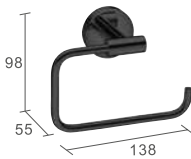
740009



740018

 <p>740047 740054</p>	 <p>740050 740045</p>	 <p>030706</p>
 <p>740053</p>	 <p>740052</p>	 <p>030662</p>
 <p>030710</p>	 <p>190052</p>	 <p>190078</p>
 <p>030661</p>	 <p>740038</p>	 <p>740042</p>
 <p>740043</p>	 <p>740046</p>	 <p>030708</p>
<p>740044</p>	 <p>030691 030692</p>	 <p>030627</p>

COMPLEMENTARY





740050
 Doppel-Haken. Schwarz
 Messing mit
 Pulverbeschichtung /
 Double Hook. Black
 Brass with powder coating

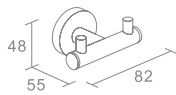

740045
 Haken. Schwarz
 Messing mit
 Pulverbeschichtung /
 Hook. Black
 Brass with powder coating



030706
 Eckseifenkörbchen
 Messing mit
 Pulverbeschichtung /
 Corner Soap basket
 Brass with powder coating

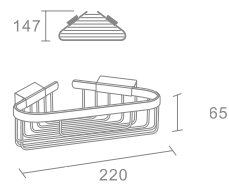



770005

Haken
Messing, verchromt /
Hook
Brass, chrome finish

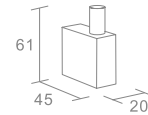

710006

Haken
Messing, verchromt /
Hook
Brass, chrome finish



740016

Haken
Messing, verchromt /
Hook
Brass, chrome finish

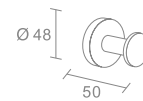

030527

Haken
Messing, verchromt /
Hook
Brass, chrome finish



740004

Doppel-Haken
Messing, verchromt /
Double Hook
Brass, chrome finish

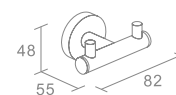

710014

Doppel-Haken
Messing, verchromt /
Double Hook
Brass, chrome finish

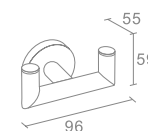



SOAP BASKETS

... mit spezieller Schraubenabdeckung
... with covered screws



030461/ 030466

Eckseifenkörbchen
Messing, verchromt /
Corner Soap Basket
Brass, chrome finish

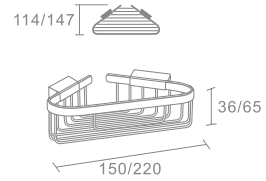

030509
Eckseifenkörbchen
Messing, verchromt /
Corner Soap Basket
Brass, chrome finish

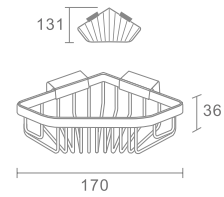

030462
Eckseifenkörbchen
Messing, verchromt /
Corner Soap Basket
Brass, chrome finish

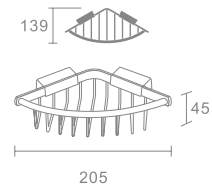

030533
Eck-Ablage
Messing, verchromt /
Corner Shelf
Brass, chrome finish

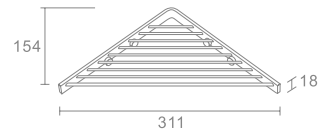

030464
Seifenkörbchen
Messing, verchromt /
Soap Basket
Brass, chrome finish

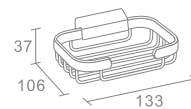

030463
Seifenkörbchen
Messing, verchromt /
Soap Basket
Brass, chrome finish

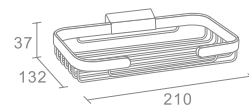

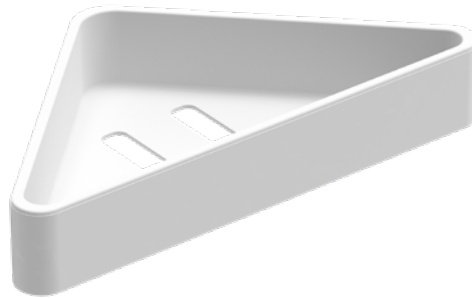
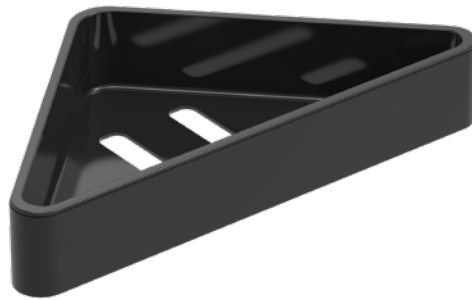

weiß / white



schwarz / black

033677 - schwarz / black
034677 - weiß / white

Seifenkörbchen
Edelstahl mit matter
Pulverbeschichtung
Herausnehmbarer ABS-
Kunststoffeinsatz /
Corner Soap basket
Stainless steel with
Matt powder coating
Removable, ABS plastic insert

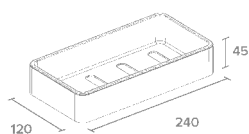

033671 - schwarz / black
034671 - weiß / white

Eckseifenkörbchen
Edelstahl mit matter
Pulverbeschichtung
Herausnehmbarer ABS-
Kunststoffeinsatz /
Corner Soap basket
Stainless steel with
matt powder coating
Removable, ABS plastic insert

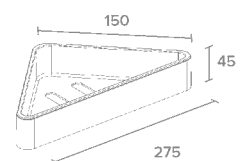



HALTEGRIFFE/ GRAB BARS



Sicherheits-Haltegriff /
Safety Grab Bar

710053/ 710054

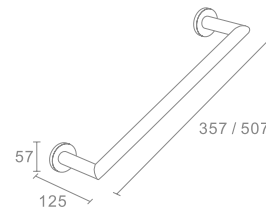

770018

Sicherheits-Haltegriff /
Safety Grab Bar

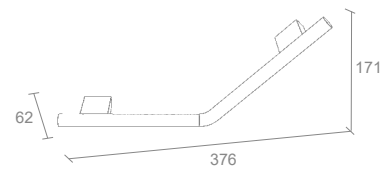

710056

Sicherheits-Haltegriff mit Seifenkörbchen
Wechselseitige Montage /
Safety Grab Bar with Soap Basket
Adjusts to left and right hand installations

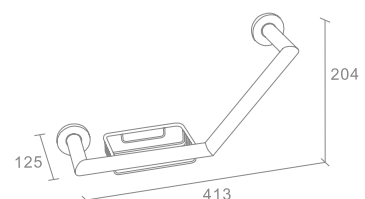





030618
Handtuchring /
Towel Ring

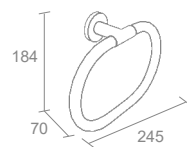



030615

Seifenspender MOON
 Satiniertes Glas. Messing, verchromt /
 Soap Dispenser MOON
 Iced glass. Brass, chrome finish

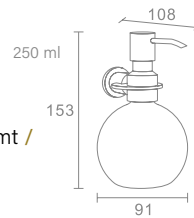

030614

Seifenspender CARLTON
 Satiniertes Glas. Messing, verchromt /
 Soap Dispenser CARLTON
 Iced glass. Brass, chrome finish

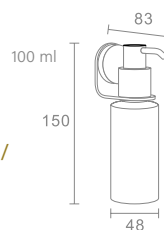



030416

Wäscheleine
Messing, verchromt /
Clothes Line
Brass, chrome finish

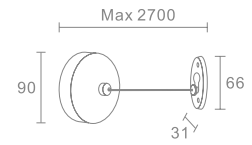

030494

Wäscheleine
Messing, verchromt /
Clothes Line
Brass, chrome finish

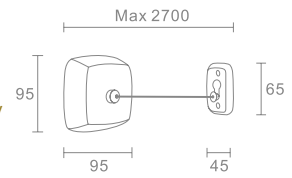

740018

WC-Bürstengarnitur. Standmodell
Edelstahl verchromt /
Toilet Brush Holder. Free standing
Stainless steel, chrome finish

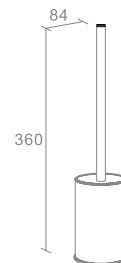



030506

Kosmetiktuchspender CUBE
Kunststoff, verchromt /
Tissue Dispenser CUBE
Plastic, chrome finish

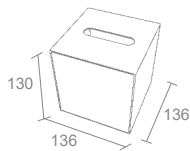

030724

Kosmetiktuchspender
ABS-Kunststoff, verchromt /
Tissue Dispenser
ABS-plastic, chrome finish

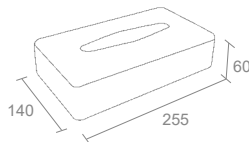

030628

Hygienebaghalter
Kunststoff, verchromt /
Sanitary Bag Dispenser
Plastic, chrome finish

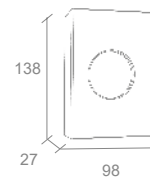

030449

Einbau- Kosmetiktuchspender
Einbaumaße: 264 x 130 x 76 mm
Messing, verchromt /
Built-in Tissue Dispenser
Built-in dimensions: 264 x 130 x 76 mm
Brass, chrome finish

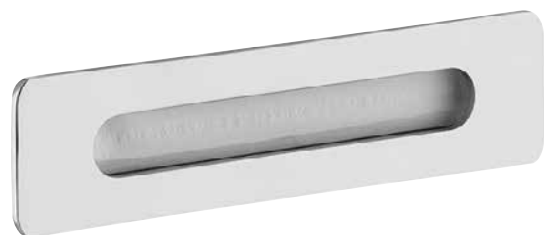
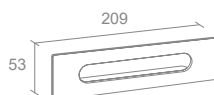

HAVE A SEAT

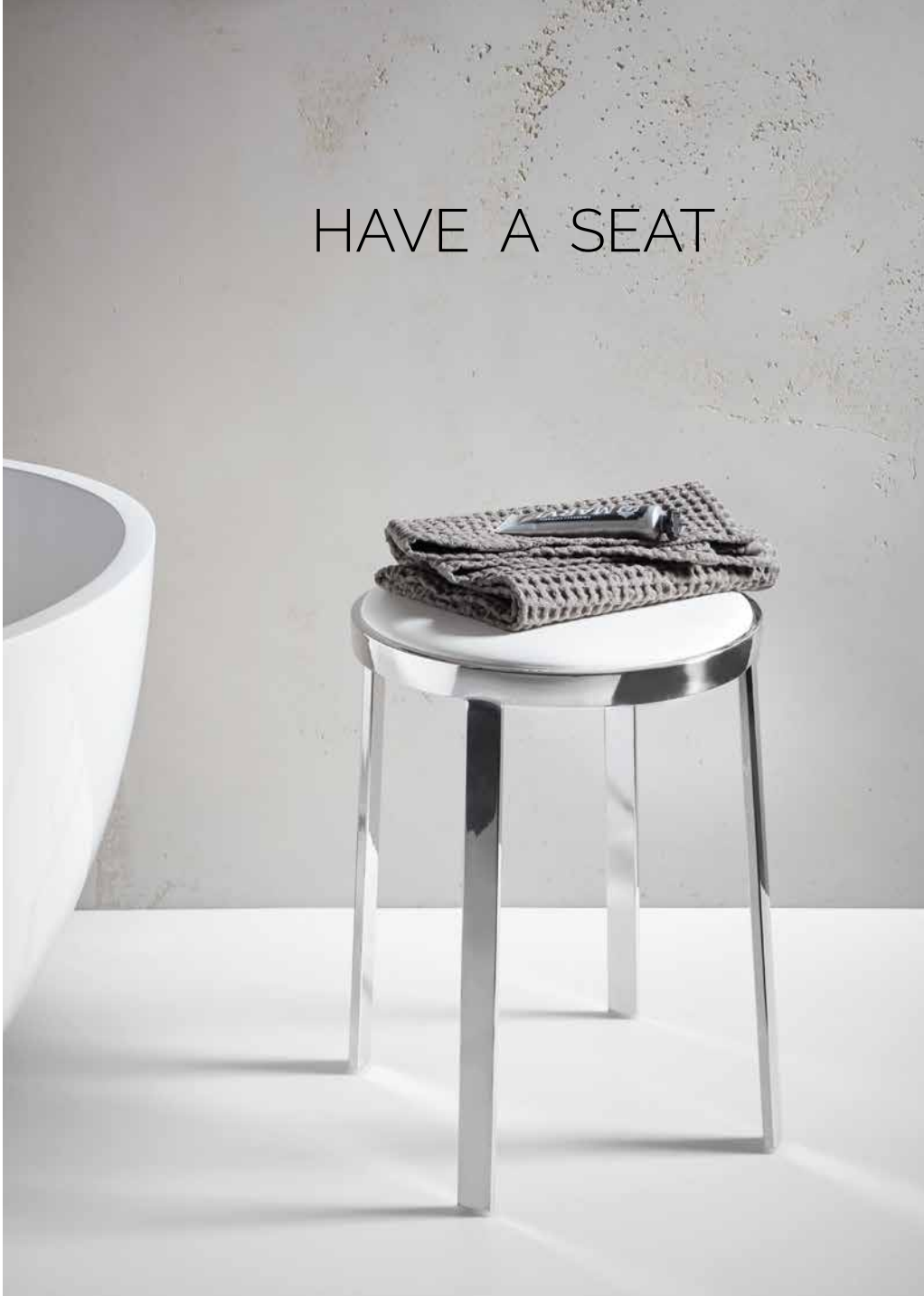

**030483**

Badezimmerhocker ANTIGUA

Sitz: PVC, weiß, gepolstert / Gestell: Metall, verchromt /

Bathroom Stool ANTIGUA

Seat: PVC, white, padded / Legs: Metal, chrome finish

**030089**

Badezimmerhocker PURI

Sitz: ABS-Kunststoff, weiß / Gestell: Metall, verchromt /

Bathroom Stool PURI

Seat: ABS-plastic, white / Legs: Metal, chrome finish

**030485**

Badezimmerhocker ZANZIBAR

Sitz: PVC, weiß, gepolstert / Gestell: Metall, verchromt /

Bathroom Stool ZANZIBAR

Seat: PVC, white, padded / Legs: Metal, chrome finish



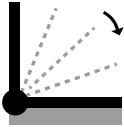

ABSENK-AUTOMATIK & STABILES PEDALSYSTEM

Ein patentiertes Hydrauliksystem ermöglicht das geräuscharme Absenken des Deckels. Das verstärkte Pedal verteilt die Kraft gleichmäßig. Ein solides System, das über 100.000 Betätigungen ermöglicht. /

SILENT SOFT CLOSE SYSTEM

Intelligent soft-close function controlled by a patented hydraulic lid system. Rib-reinforced steel pedal distributes foot force equally. Extending service life in upwards of 100,000 steps.



ANTI-FINGERABDRUCK

Hochwertiger Edelstahl mit spezieller Anti-Fingerabdruck-Lackierung. Die Oberfläche bleibt frei von Abdrücken und ist einfacher zu reinigen. /

FINGERPRINT RESISTANT

High-quality stainless steel with fingerprint resistant coating keeps the bin clean and easy to maintain.

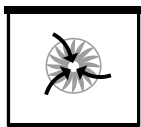

BEUTELFIXIERUNG

Plastikbeutel lassen sich mittels einer Befestigungsöse am Inneneimer problemlos befestigen. /

PLASTIC BAG FIXER

Plastic bag fixer helps secure the bag with no visible excess, keeping the bags neat and orderly.



SICHERER STAND

Kunststoffboden mit rutschfesten, oberflächen-schonenden Pads geben dem Eimer Stabilität.

SOLID BASE

Plastic bottom, non-skid base and insulated pads are gentle on the floor and keeps the bin steady.





WASTE NOT

Manage your waste

In Aliseo's moderner und herausragender Handwerkskunst spiegeln sich technische Innovationen wider, die gleichzeitig durch Ihren hohen Nutzen und die leichte Handhabung bestechen. /

Contemporary craftsmanship at its finest, Aliseo's sensible technology and intelligent solutions combine clarity of purpose with utilitarian beauty.

PRESTIGE



PRESTIGE

Hygieneeimer
Herausnehmbarer Kunststoffeinsatz
Edelstahl,

Step Bin
Removable plastic inner bin
Stainless steel



030654
chrom, gebürstet /
brushed chrome

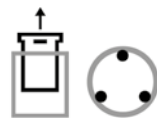

030692
schwarz /
black



030655
chrom, gebürstet /
brushed chrome

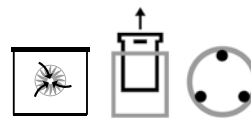

030691
schwarz /
black

THE
CLASSIC



Herausnehmbarer, solider INNENEIMER
Verstärktes Gelenk mit Tragegriff /
Durable lift-out INNER BUCKET catches messy drips
Strong back handle



PRESTIGE



Ideal für Suiten, Apartments oder Ferienwohnungen.

EZ STAY Hygieneeimer für einen unbeschwerten Aufenthalt. /

Ideal for suite, apartment or extended stay applications.

The EZ STAY BIN makes your guest's stay easier.

LANGLEBIG

Extra breites Pedal verteilt die Kraft gleichmäßig. Ein solides Pedalsystem gewährleistet über 100.000 Betätigungen. /

DURABLE

Rib-reinforced extra large steel pedal distributes foot force equally, extending service life in upwards of 100,000 steps.



2-FACH INNENEIMER

Zwei separate Inneneimer für einfache Mülltrennung und Müllentsorgung. /

DOUBLE INNER BUCKETS

Double inner liners for easy separation and recycling.



STAY-OPEN-FUNKTION

Komfortable Deckelverankerung bei längerem Gebrauch. /

STAY OPEN DESIGN

Lid lock-out for convenient longer term usage.



030659

PRESTIGE EZ STAY

Hygieneeimer - 10 L + 9 L

Zwei herausnehmbare

Kunststoffeinsätze

Edelstahl, gebürstet /

Step Bin - 10 L + 9 L

Two removable plastic inner bins
Stainless steel, brushed finish





ABNEHMBARER RING INNENEIMER OHNE ABDECKUNG
 Offener Eimer für mühelose Abfallbeseitigung. Abnehmbarer Ring und Inneneimer mit Abfallbeutelfixierung und Henkel ermöglichen eine saubere Entsorgung. /
 LIFT-OFF LID INNER BUCKET OPEN TOP
 Open mouth design for effortless trash discard. Lift-off lid and removable liner with waste bag fixer and sure-grip handle make for fast easy trash disposal.

030660

PRESTIGE

Abfallbehälter - 9 L

Herausnehmbarer

Kunststoffeinsatz

Edelstahl, gebürstet /

Waste Bin - 9 L

Removable plastic inner bin

Stainless steel, brushed finish





030657

PRESTIGE

Hygieneeimer - 5 L

Herausnehmbarer

Kunststoffeinsatz

Edelstahl, gebürstet /

Step Bin - 5 L

Removable plastic inner bin

Stainless steel, brushed finish





030720

PRESTIGE

Abfallbehälter - 3 x 3,5 L
 3 herausnehmbare Kunststoffeinsätze
 (schwarz, grün, blau)
 Edelstahl, gebürstet /
 Waste Bin - 3 x 3,5 L
 3 removable plastic inner bins
 (black, green, blue)
 Stainless steel, brushed finish

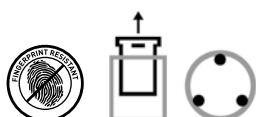

030712

PRESTIGE

Abfallbehälter - 2 x 5 L
 2 herausnehmbare Kunststoffeinsätze
 (schwarz, grün)
 Edelstahl, gebürstet /
 Waste Bin - 2 x 5 L
 2 removable plastic inner bins
 (black, green)
 Stainless steel, brushed finish

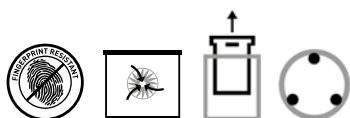

030627

Abfallbehälter- 13 L
 Feuerfest. Abnehmbarer Deckel
 Kunststoffbodenring
 Metall. Schwarz-anthrazit /
 Waste Bin - 13 L
 Fire-proof. Removable top
 Plastic ring at the bottom
 Metal. Black-anthracite





**030490****BOHEMIA**

Mechanisch - Extra groß
 Großzügige Trittfläche
 Verzerrungsfreie Glasscheibe
 Solide Konstruktion
 Tragkraft max. 160 kg
 Teilung 500 g
 Anzeige in Kilo und Pfund
 Material: Metall, korrosions-
 geschützte Emailbeschichtung /
 Mechanical - Extra Large
 Comfortable platform
 Fog-free glass lens
 Durable construction
 Capacity max. 160 kg
 Graduation 500 g
 Display kg and lbs
 Material: metal / corrosion
 resistant enamelled coating

435  320 | 68



030626

NEVIS

Elektronisch
 6-mm-starkes Sicherheitsglas
 Tragkraft max. 150 kg
 Teilung 100 g
 Umschaltbar auf Pfund (lbs)
 Step-on-Funktion
 4 Gewichtssensoren
 Automatische Abschaltung
 3 x 1,5V-AAA-Batterien
 Material Unterteil: ABS-Kunststoff /
 Electronic
 6 mm-thick safety glass
 Capacity max. 150 kg
 Graduation 100 g
 Switchable to pounds (lbs)
 Step-On technology
 4 integrated sensors
 Auto shut-off
 3 x 1,5V-AAA batteries
 Material underpart: ABS plastic

338 330 | 21/35



030475

FUTURA

Elektronisch
 6-mm-starkes Sicherheitsglas
 Tragkraft max. 200 kg
 Teilung 100 g
 Umschaltbar auf Pfund (lbs)
 4 Gewichtssensoren
 Automatische Abschaltung
 Long-life Lithium Batterie
 Material Unterteil: korrosionsgeschützte
 Epoxid- Kunststoffbeschichtung /
 Electronic
 6 mm-thick safety glass
 Capacity max. 200 kg
 Graduation 100 g
 Switchable to pounds (lbs)
 4 integrated sensors
 Auto shut-off
 Long-life Lithium battery
 Material underpart: Corrosion resistant
 Epoxy-plastic coating

300 300 | 35

**030653****STEP**

Elektronisch
 6-mm-starkes Sicherheitsglas
 Tragkraft max. 150 kg
 Teilung 100 g
 Umschaltbar auf Pfund (lbs)
 Step-on-Funktion
 4 Gewichtssensoren
 Automatische Abschaltung
 1 x 3V Lithium Batterie
 Material Rahmen und Unterteil:
 ABS Kunststoff /
 Electronic
 6 mm-thick safety glass
 Capacity max. 150 kg
 Graduation 100 g
 Switchable to pounds (lbs)
 Step-on technology
 4 integrated sensors
 Auto shut-off
 1 x 3V lithium battery
 Material frame and underpart: ABS plastic

306  | 22

030544**TEMPO**

Elektronisch
 8-mm-starkes Sicherheitsglas
 Tragkraft max. 180 kg
 Teilung 100 g
 Umschaltbar auf Pfund (lbs)
 4 Gewichtssensoren
 Automatische Abschaltung
 80 x 40 mm Display-Anzeige mit
 blauer Hintergrundbeleuchtung
 4x AAA Batterien
 Material Unterteil: ABS Kunststoff /
 Electronic
 8 mm-thick safety glass
 Capacity max. 180 kg
 Graduation 100 g
 Switchable to pounds (lbs)
 4 integrated sensors
 Auto shut-off
 80 x 40 mm LCD display
 with blue backlight
 4x AAA batteries
 Material underpart: ABS plastic

330  | 28

WASSERKOCHER



KETTLES





Bonjour
... A new Day



DESIGNED FOR A DIFFERENCE

1.



2.



3.



1. Einfaches Reinigen durch besonders breiten Ausguss und nahtlos gezogener Edelstahlbehälter
Doppelwändiges Gehäuse: innen - Edelstahl, außen - wärmeisolierender Kunststoff
 2. Verriegelter Sicherheitsklappdeckel, öffnet auf Knopfdruck mit schmaler Ausgusstülle
- zum einfachen, tropfenfreien Ausgießen
 3. Ergonomisch geformter Kunststoff-Griff (bleibt angenehm kühl) mit beleuchtetem Ein-/Ausschalter /
1. Extra wide mouth and seamless canister improves ease of cleaning
Double wall construction – stainless steel cylinder with a cool-touch stain resistant thermoplastic exterior
 2. Sturdy interlocking safety lid with wide-mouth aperture
- easy to fill and clean
 3. Full grip safety handle with illuminated power switch

BONJOUR

0,6 Liter Füllmenge
Integriertes Heizelement
Kabellos, 360° drehbar
Abschaltautomatik
Trockenlaufsicherung
Kontrollleuchte
Deckel mit Sicherheitsverriegelung
Doppelwändiges Gehäuse:
innen - Edelstahl
außen - wärmeisolierender Kunststoff

0.6 litre capacity
Integrated heating element
Cordless, 360° rotation
Automatic shut-off
Boil dry protection
Indicator light
Lid with safety interlock
Double wall construction
Inner stainless steel cylinder
Insulated thermoplastic exterior



220-240 V, 50/60 Hz 1000 W

170281

schwarz matt /
black matt

170282

elfenbein/ schwarz /
ivory/black



185 - mit Sockel / with base
165 - ohne Sockel / without base

Ø 134 - Sockel / base
190 max. Breite /width

SMALLER IS SMARTER – WATER & ENERGY SAVING

MINI

0,5 Liter Füllmenge	0.5 litre capacity
Integriertes Heizelement	Integrated heating element
Kabellos, 360° drehbar	Cordless, 360° rotation
Abschaltautomatik	Automatic shut-off
Trockenlaufsicherung	Boil dry protection
Kontrollleuchte	Indicator light
Deckel mit Sicherheitsverriegelung	Lid with safety interlock
Edelstahlgehäuse	Stainless steel housing

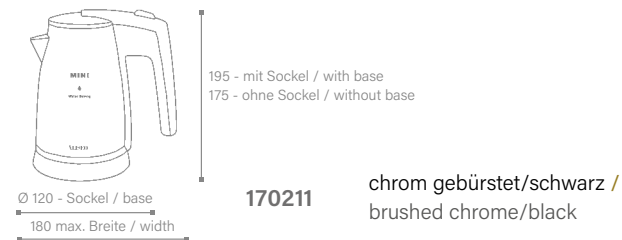
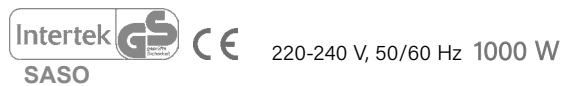

1. Ergonomisch geformter Kunststoff-Griff (bleibt angenehm kühl) mit beleuchtetem Ein-/Ausschalter
 2. Geringe Standfläche durch 0,5 L Design
Edelstahlgehäuse, Oberfläche chrom gebürstet
 3. 360° Basisstation mit Strix-Controller für die Sicherheit der Gäste
 4. Verriegelter Sicherheitsklappdeckel, öffnet auf Knopfdruck
 5. Schmale Ausgusstülle - zum einfachen, tropfenfreien Ausgießen /
1. Safety-grip handle with illuminated power switch
 2. Cylindrical low-profile 0.5 liter footprint;
stainless steel construction with brushed surface finish
 3. 360° STRIX interface platform ensures guest's safety while optimizing performance
 4. Sturdy interlocking safety lid
 5. Easy pour spout with wide mouth fill



Alle Aliseo Wasserkocher verfügen über den patentierten STRIX Schutzmechanismus. Dieser gewährleistet die automatische Abschaltung bei Erreichen des Kochvorgangs, bei Entnahme des Behälters von der Basisstation und den Trockengehschutz. Eine maximale Sicherheit für die Gäste. /

All Aliseo kettles incorporate patented STRIX thermostatic controls ensuring maximum guest safety: auto shut-off, boil dry protection and steam shut-down functions.



MINI





Elegante verchromte Oberfläche /
Elegant chrome finish

EMPIRE

0,8 Liter Füllmenge	0.8 litre capacity
Integriertes Heizelement	Concealed heating element
Kabellos, 360° drehbar	Cordless, 360° rotation
Abschaltautomatik	Automatic shut-off
Trockenlaufsicherung	Boil dry protection
Kontrollleuchte	Indicator light
Deckel mit Verriegelung	Lid with safety interlock
Edelstahlgehäuse	Stainless steel housing



220-240 V, 50/60 Hz 1000-1200 W

170167 chrom/schwarz /
chrome/black



170 - mit Sockel / with base
150 - ohne Sockel / without base

Ø 158 - Sockel / base
210 max. Breite / width



PUZZLE

Ablagebehälter
Material: Melamin
mit Porzellan-Optik
schwarz /
Sachet Box
Material: Melamine
with porcelain optic
black

170240
151 x 55 x 76 mm

170241
76 x 55 x 76 mm



Einziehbares Netzkabel /
Retractable power cord

TEA X-PRESS

0,8 Liter Füllmenge
Integriertes Heizelement
Kabellos, 360° drehbar
Doppelwandiges Gehäuse:
- innen: Edelstahl
- außen: wärmeisolierender Kunststoff
Deckel mit Sicherheitsverriegelung
Abschaltautomatik
Trockenlaufsicherung
Kontrollleuchte
Strix-Controller
Füllstandsanzeige mit LED-Licht

0.8 litre capacity
Concealed heating element
Cordless, 360° rotation
Double layer kettle:
- inside: stainless steel
- outside: insulated cool touch housing
Lid with secure safety interlock
Automatic shut-off
Boil dry protection
Indicator light
Strix controller
Water gauge with LED light



220-240 V, 50/60 Hz 1000-1200 W

170300

schwarz matt /
black matt



210 - mit Sockel / with base
190 - ohne Sockel / without base

TABLETT-SETS



TRAY SETS



SPACE OASIS

Simply Perfect



MINI TRAY ENSEMBLE

Eco-luxe Effizienz kombiniert Wasser- und Energiesparfunktionen auf kleinster Fläche
... eine sinnvolle Zusammenstellung. /

Eco-luxe efficiency combines water and energy saving functions in a small space
... it all makes sense.



3
IN ONE



KERAMIKTASSE / CERAMIC MUG
schwarz-weiß /
black/white



HOLZTABLETT / BRIDGE TRAY
Hochwertiges, robustes Bambusholz
Schubfach aus langlebigem Melamin /
Elegantly finished bamboo construction
Durable melamine condiment tray



MINI
Wassersparendes 0,5 L Design /
0,5 liter water- saving design

SPACE OASIS

Wasserkocher-Tablett-Set /
Water Kettle Tray Set **170259**

Holztablett /
Bridge Tray **170254**

Tasse /
Mug **170258**

MINI Wasserkocher
chrom gebürstet / schwarz
Weitere Information siehe Seite 9

BRIDGE TRAY, Holztablett mit Schubfach
260 x 44 x 160 mm (B x H x T)
Material: Bambus und Melamin
mahagoni/matt schwarz

Zwei Keramik-Tassen
250 ml
schwarz, innen weiß
Höhe 100 mm, Ø 85 mm

MINI Water Kettle
brushed chrome / black
Further information on page 3

BRIDGE TRAY, wooden tray with drawer
260 x 44 x 160 mm (W x H x D)
Material: bamboo and melamine
mahogany / matt black

Two Ceramic Mugs
250 ml
black, inside white
Height 100 mm, Ø 85 mm

COURTESY TRAY



* Abgebildet mit / Shown with Wasserkocher/ kettle BONJOUR Art. 170282 und Behälter Puzzle /
Puzzle boxes Art. 170241
Kaffeemaschine und Kapseln sind Dekoration / Coffee machine and capsules are decoration.

Schmale Tablett in Porzellan-Optik bieten einen attraktiven Rahmen für Nespresso®
Kaffeemaschinen und / oder Tee-Service-Präsentationen.

Langlebige Melamin-Konstruktion ist leicht zu reinigen und widerstandsfähig gegen
Rissbildung. Einzeln oder zusammen in Kombination mit Kaffeemaschinen und
Wasserkocher Ensembles. /

Low profile porcelain optic tablett provide an attractive setting for Nespresso® coffee
machines and/or Tea service presentations. Durable melamine construction is easy to
clean and resistant to splintering and cracking. Works individually or collectively in com-
bination with any number of similar coffee machines and tea kettle ensembles.

170277

COURTESY TRAY

schwarz

200 x 16 x 400 mm

Material: Melamin, Porzellan-Optik

black

200 x 16 x 400 mm

Material: Melamine with porcelain optic

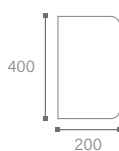



* Abgebildet mit / Shown with Wasserkocher/ kettle EMPIRE Art. 170167

- 01. Servierblech 324 x 21 x 131 mm /
Serving tray 324 x 21 x 131 mm
- 02. Grundblech 400 x 20 x 330 mm /
Base tray 400 x 20 x 330 mm
- 03. Produktablage 130 x 40 x 100 mm /
Sachet tray 130 x 40 x 100 mm

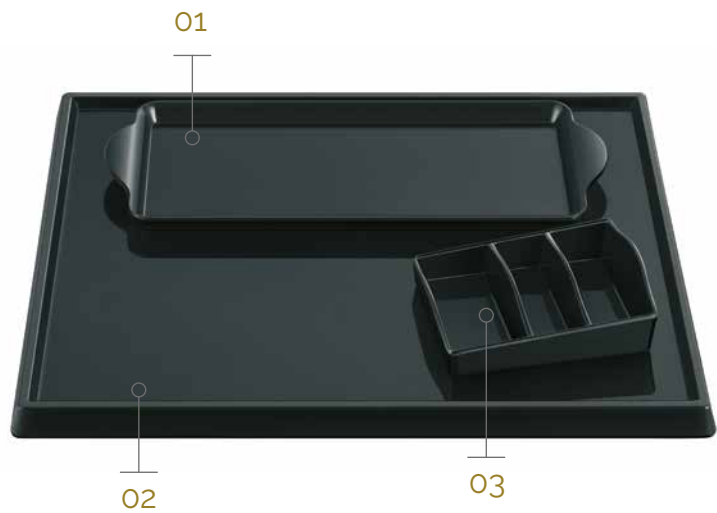

WELCOME TRAY SOLUTION

Tabletset	Tray Set
Material: Melamin mit Porzellan-Optik schwarz	Material: Melamine with porcelain optic black

Komplettes Set / Complete Set	170229
Grundblech / Base Tray	170226
Servierblech / Serving Tray	170227
Produktablage / Sachet Tray	170228

LONDONER

LONDONER NOIR





The Londoner



A Classical Tradition

Handgefertigte textile Kunstleder-Accessoires bieten ein dauerhaftes Statement für Qualität, Raffinesse und Funktion.

Traditionell im Design und luxuriös im Look bietet die LONDONER-Kollektion jedem gut ausgestatteten Gästezimmer einen geschätzten letzten Schliff.

Die harmonische, neutralen Farben schwarz und taupe fügen sich unaufdringlich in jede Zimmereinrichtung ein. /

Hand-crafted textile faux accoutrements provide an enduring statement of quality, sophistication and function.

Traditional in design and luxurious in their look and feel the LONDONER collection provides a much appreciated finishing touch to any well-appointed guestroom.

Attractive neutral taupe and black color complements any decor.

Konstruktion: Die wasserfeste Oberfläche wird durch einen geruchlosen, ungiftigen Kleber gesichert. Die Sandwich-Fertigung besteht aus PV-Kunstleder, das über ein glattes, kartonähnliches Material und eine stabile MDF-Faserplatte gelegt ist. (Die Oberfläche und Konfiguration des Leders kann je nach Artikel variieren.) /

Construction: Water resistant surface is secured via an odorless non-toxic adherent.

Sandwich fabrication features PV faux leather, layered over a smooth carton-like material and a sturdy MDF fiberboard. (Inside leather surface and configuration may vary depending on article.)

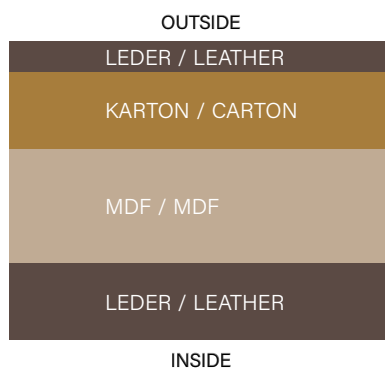

* Andere Farben und kundenspezifische Abmessungen sind auf Anfrage erhältlich, abhängig von Farbe, Menge und Lieferzeit. /

* Other colors and customized dimensions are available upon request depending on color, quantity and lead time



Die hochwertige Ausarbeitung beinhaltet erlesene Details und die stabilen und aufwändig gefertigten Nähte eine lange Lebensdauer. /

Premium quality designs features exquisite details and rugged ribbed stitching for extended longevity.

FLECKENENTFERNUNG

Das Lederimitat ist wasserabweisend und bedarf daher nur einer minimalen Pflege. Es kann einfach mit einer milden Seife gereinigt werden. Verwenden Sie KEINE aggressiven Reinigungsmittel oder auf Säure basierende Chemikalien.

Befeuchten Sie ein sauberes, weiches Tuch mit etwas Wasser und Seife. Wringen Sie ggf. überschüssiges Wasser aus, um die Oberfläche nicht unnötiger Feuchtigkeit auszusetzen. Wischen Sie die Flecken mit dem feuchten Tuch sanft ab. Reinigen Sie den Bereich mit einem sauberen, trockenen und weichen Tuch nach. Um unnötige Spuren zu vermeiden, sollte die Oberfläche nur mit gerade so viel Wasser benetzt werden, dass es zum effektiven Entfernen der Flecken ausreicht. Anschließend sollte das Accessoire unverzüglich getrocknet werden.

STAIN REMOVAL

The faux leather is non-porous and therefore requires little maintenance. It can be easily cleaned with a mild soap solution. Do NOT use harsh detergents or acidic based chemical solutions.

Dampen a clean soft rag with soapy water; squeeze-off the excess water to avoid over-saturating the surface. Gently wipe the stains clean with the damp rag.

Wipe off the area with a clean dry soft rag. The trick is to dampen the leather with minimal moisture to allow efficient cleaning and allow it to dry quickly to avoid damage.

Londoner Noir



The Night Begins the Day



LONDONER
COLOR LINE
Bringing Color To Life





LONDONER, eine klassische Kunstlederkollektion, ist jetzt in einer Vielzahl von modernen Farbtönen und Texturen erhältlich. Die **COLOR LINE** von Aliseo ist eine perfekt integrierte, frische Ästhetik, die die harmonische Umwandlung der Komponenten des Raumes vervollständigt. Warm und einladend, stilvoll und faszinierend, **COLOR LINE** strahlt die Persönlichkeit des Gästezimmers aus und ist eine natürliche Ergänzung zu den handgefertigten Londoner Accessoires.

Perfekt proportioniert und intelligent gestaltet, wird das reiche Erscheinungsbild von LONDONER durch seine glatte Textur und die aufwendig verarbeiteten Nähte noch verstärkt.

Die schlichten, eleganten und raffinierten Formen in Kombination mit luxuriösen Farben verleihen jedem Gästezimmer einen nuancierten Reiz des persönlichen Designs.

Erhältlich in einer Reihe von brillanten Farben - bitte kontaktieren Sie uns für weitere Informationen. /

The LONDONER, a classic faux leather collection, is now available in a multitude of modern hues and textures. Aliseo's **COLOR LINE** is a flawlessly integrated fresh aesthetic that completes the harmonious transformation of the components of the room. Warm and inviting, stylish and intriguing, **COLOR LINE** radiates the personality of the guestroom and is a natural complement to Londoner's hand-crafted tea service items and fashionable accoutrements.

Perfectly proportioned and intelligently designed, the Londoner's rich appearance is enhanced by its smooth texture, and intricately finished seams.

Simple, stylish, and sophisticated the Londoner's stream-lined forms combine with luxury colors to add a nuanced allure of personal design to any guestroom.

Available in a brilliant array of captivating colors - please contact us for particulars.

THE LONDONER



LONDONER NOIR



* LONDONER NOIR
Abgebildet mit Wasserkocher Mini. Tasse ist Dekoration/
Shown with Bonjour kettle. Cup is decoration

THE LONDONER
Abgebildet mit Wasserkocher BONJOUR. Tasse ist Dekoration/
Shown with Bonjour kettle. Cup is decoration



190058 - taupe
 190083 - schwarz / black
 Tablett groß
 mit Schubfach /
 Tray big
 with drawer



190057 - taupe
 190084 - schwarz / black
 Tablett klein
 mit Schubfach /
 Tray small
 with drawer





190001 - taupe
 190068 - schwarz / black
 Tablett /
 Tray



190003 - taupe
 190070 - schwarz / black
 Ablagebehälter
 mit zwei Fächern /
 Sachet Box
 with two compartments



190002 - taupe
 190069 - schwarz / black
 Ablagebehälter
 mit zwei Fächern /
 Sachet Box
 with two compartments

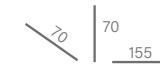

190063 - taupe
 190089 - schwarz / black
 Glas-/Tassenuntersetzer
 für Gläser/Tassen/Teebeutel /
 Coaster
 for cups/glasses/tea bags





* Abgebildet mit / Shown with Wasserkocher/ kettle BONJOUR Art. 170282.
Tasse / Mug Art. 170258
Kaffeemaschine & Kapseln sind Dekoration. / Coffee machine & capsules are decoration.



IN
2 GRÖSSEN
IN
2 SIZES

190061 - taupe

190087 - schwarz / black

Tablett

mit 2 Löcher ø 55 mm für Kabel des Wasserkochers /
Tray

with 2 holes ø 55 mm for cable of water kettle



190060 - taupe

190086 - schwarz / black

Tablett

mit Loch ø 55 mm für Kabel des Wasserkochers /
Tray

with hole ø 55 mm for cable of water kettle





190062 - taupe

190088 - schwarz / black

Utensilienbox

mit 5 Fächern und abklappbarem Deckel /

Stationary Box

with 5 compartments and hinged lid



190009 - taupe

190072 - schwarz / black

Utensilienbox

mit 3 Fächern /

Stationary Box

with 3 compartments



190065 - taupe

190091 - schwarz / black

Kapselbehälter

mit wendbarer Einlage für 2 oder 4 Kapseln /

Coffee Capsule Box

with reversible insert for 2 or 4 capsules



190059 - taupe

190085 - schwarz / black

Minibar-Tablett /

Minibar Tray





190004 - taupe

190071 - schwarz / black

Glas-/Tassenuntersetzer /
Coaster



190006 - taupe

190051 - schwarz / black

Eiswürfelbehälter, 1 Liter
mit Deckel und Zange. Edelstahl /
Ice Cube Container, 1 litre
with lid and tongs. Stainless steel





190016 - taupe

190052 - schwarz / black

Kosmetiktuchspender
mit magnetischer Bodenklappe /
Tissue Dispenser
with magnetic trap at the bottom



190017 - taupe

190078 - schwarz / black

Kosmetiktuchspender
mit magnetischer Bodenklappe /
Tissue Dispenser
with magnetic trap at the bottom





190011 - taupe

190073 - schwarz / black

Notizblockunterlage
mit Vertiefungen für Block und Stift /
Note Pad
with cut-outs for note pad and pen



190012 - taupe

190074 - schwarz / black

Notizblockhalter
mit magnetischer Klemmschiene
und Stifthalter /
Note Pad Holder
with magnetic fold and pen holder





190028 - taupe

190081 - schwarz / black

Info-Mappe A4
mit 2-Ring-Mechanik /
Service Binder A4
with two ring clamp



190027 - taupe

190054 - schwarz / black

Info-Mappe A5
mit 2-Ring-Mechanik /
Service Binder A5
with two ring clamp



190066 - taupe

190092 - schwarz / black

Info-Mappe A4
mit Stifthalter und 4 Fächer/
Service Binder A4
with pen holder and 4 compartments





190030 - taupe

190053 - schwarz / black

Tischauflage
mit magnetischer Klemmschiene /
Desk Pad
with magnetic fold



190064 - taupe

190090 - schwarz / black

Tischunterlage /
Desk pad



190029 - taupe

190082 - schwarz / black

Rechnungsmappe
mit magnetischer Klemmschiene
und Stifthalter /
Bill Presenter
with magnetic fold and pen holder





190014 - taupe

190076 - schwarz / black

TV-Mappe mit Fach für Fernbedienung
und Sichtfenster für Programmliste /
Remote Control Binder
with compartment for TV channel list



190015 - taupe

190077 - schwarz / black

Fernbedienungsständer /
Remote Control Holder



190018 - taupe

190079 - schwarz / black

Info-Wandhalter
z.B. für Wäscheservice /
Service Wall Holder
e.g. for laundry information





190013 - taupe

190075 - schwarz / black

Tischuhr - batteriebetrieben
mit Weckfunktion und Beleuchtung /
Table Clock - Battery-Powered
with alarm and lighting

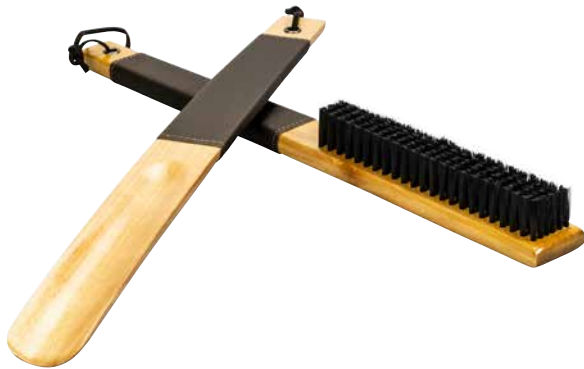

190019 - taupe

190048 - schwarz / black

Kleiderbürste
Holz mit Aufhängeschlaufe /
Clothes Brush
wood with hanger

380

190020 - taupe

190049 - schwarz / black

Schuhlöffel
Holz mit Aufhängeschlaufe /
Shoe Horn
wood with hanger

380



190023 - taupe

190080 - schwarz / black

Zeitschriftenständer
mit zwei Fächer /
Magazine Holder
with two compartments



LONDONER



190067 - taupe
190093 - schwarz / black
THE LONDONER
 Abfallbehälter - 2 x 6 L
 Mit zwei herausnehmbaren Metalleinsätzen
 103 x 334 x 205 mm/
 Waste Bin - 2 x 6 L
 With two removable metal liners
 103 x 334 x 205 mm



190026 - taupe
190094 - schwarz / black
THE LONDONER
 Abfallbehälter - 10 L
 Herausnehmbarer Metalleinsatz /
 Waste Bin - 10 L
 Removable metal liner



520694
 Optionaler separater Einsatz
 passend für Art. 190026 & 190094 /
 Optional Waste Bin Separator
 fits Art. 190094 & 190026





190025 - taupe

190055 - schwarz / black

THE LONDONER

Abfallbehälter - 9 L

Metall mit abnehmbarer Kunstleder-Ummantelung/

Waste Bin - 9 L

Metal with removable casing





190001

Tablett
Tray



190002

Ablagebehälter
Sachet Box



190003

Ablagebehälter
Sachet Box



190065

Kaffee kapsel
behälter
Coffee Capsule Box

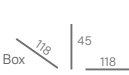

190060

Tablett
Tray



190061

Tablett
Tray



190057

Tablett
Tray



190058

Tablett
Tray



190059

Minibar-Tablett
Minibar Tray

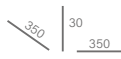

190009

Utensilienbox
Storage Tray



190062

Utensilienbox
Storage Tray

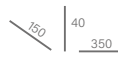

190004

Untersetzer
Coaster



190063

Tablett-Meeting
Tray-Meeting



190064

Tischunterlage
Desk Pad

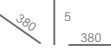

190006

Eiswürfelbehälter
Ice Cube Container



190016

Kosmetiktuch-
spender
Tissue Dispenser

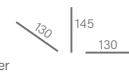

190017

Kosmetiktuch-
spender
Tissue Dispenser

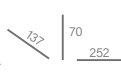

190013

Tischuhr
Table Clock



190014

TV-Mappe
Remote Control
Binder

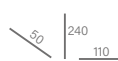

190015

Fernbedienungs-
ständer
Remote Control Holder





190030
Tischauflage
Desk Pad
405 | 14
500



190027
Info-Mappe A5
Service Binder A5
40 | 245
193



190028
Info-Mappe A4
Service Binder A4
40 | 320
246



190066
Info-Mappe A4
Service Binder A4
30 | 320
246



190029
Rechnungs-
mappe
Bill Presenter
20 | 240
128



190011
Notizblock-
unterlage
Note Pad
155 | 7
165



190012
Notizblockhalter
Note Pad Holder
170 | 7
130



190018
Info-Wand-
halterung
Service Wall Holder
20-40 | 320
240



190019
Kleiderbürste
Clothes Brush
380



190023
Zeitschriften-
ständer
Magazine Holder
330 | 230
330



190025
Abfallbehälter, 9 L
Waste Bin, 9 L
225 | 270



190026
Abfallbehälter,
10 L
Waste Bin, 10 L
235 | 363
235



190067
Abfallbehälter,
2 x 6 L
Waste Bin, 2 x 6 L
300 | 250
300



520694
Metalleinsatz, türkis,
für Art. 190094
Waste Bin Separator
Metal, turquoise
fits Art. 190094
205 | 334
103



190068

Tablett
Tray



190069

Ablagebehälter
Sachet Box



190070

Ablagebehälter
Sachet Box



190091

Kaffee kapsel
behälter
Coffee Capsule Box



190086

Tablett
Tray



190087

Tablett
Tray



190084

Tablett
Tray



190083

Tablett
Tray



190085

Minibar-Tablett
Minibar Tray



190072

Utensilienbox
Storage Tray



190088

Utensilienbox
Storage Tray



190071

Untersetzer
Coaster



190089

Tablett-Meeting
Tray-Meeting



190090

Tischunterlage
Desk Pad



190051

Eiswürfelbehälter
Ice Cube Container



190052

Kosmetiktuch-
spender
Tissue Dispenser



190078

Kosmetiktuch-
spender
Tissue Dispenser



190075

Tischuhr
Table Clock



190076

TV-Mappe
Remote Control
Binder



190077

Fernbedienungs-
ständer
Remote Control Holder



LONDONER NOIR

schwarz/ black



190053
Tischauflage
Desk Pad
405 | 14
500



190054
Info-Mappe A5
Service Binder A5
40 | 245
193



190081
Info-Mappe A4
Service Binder A4
40 | 320
246



190092
Info-Mappe A4
Service Binder A4
30 | 320
246



190082
Rechnungs-
mappe
Bill Presenter
20 | 240
128



190073
Notizblock-
unterlage
Note Pad
155 | 7
165



190074
Notizblockhalter
Note Pad Holder
170 | 7
130



190079
Info-Wand-
halterung
Service Wall Holder
20-40 | 320
240



190048
Kleiderbürste
Clothes Brush
380

190049
Schuhlöffel
Shoe Horn
380



190080
Zeitschriften-
ständer
Magazine Holder
330 | 230
330



190055
Abfallbehälter, 9 L
Waste Bin, 9 L
225 | 270



190094
Abfallbehälter,
10 L
Waste Bin, 10 L
235 | 363
235



190093
Abfallbehälter,
2 x 6 L
Waste Bin, 2 x 6 L
300 | 250
300



520694
Metalleinsatz, türkis,
für Art. 190094
Waste Bin Separator
Metal, turquoise
fits Art. 190094
205 | 334
103

KOFFERABLAGEN



LUGGAGE RACKS



KOFFERABLAGEN

KOFFERABLAGE

Mit Rückenlehne
Beige Gurtbänder
Material: Edelstahl
Oberfläche, verchromt

geklappt (B x H x T)
67,5 x 89 x 9 cm

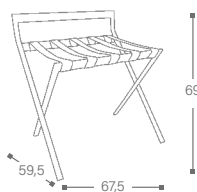

080069

chrom /
chrome

LUGGAGE RACK

With back
Beige straps
Material: stainless steel
Surface, chrome plated

folded (W x H x D)
67,5 x 89 x 9 cm



KOFFERABLAGE

Schwarze Gurtbänder
Material: Stahlrohr

Mit Rückenlehne
geklappt (B x H x T)
68 x 85 x 10 cm

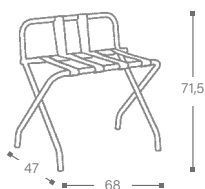

080053

chrom /
chrome

080088

schwarz /
black

LUGGAGE RACK

With black straps
Material: steel tube

With back
folded (W x H x D)
68 x 85 x 10 cm



Ohne Rückenlehne
geklappt (B x H x T)
68 x 65 x 9 cm

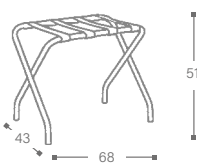

080055

chrom /
chrome

080087

schwarz /
black

Without back
folded (W x H x D)
68 x 65 x 9 cm



KOFFERABLAG

Schwarze Gurtbänder
Material: Holz, Buche

Mit Rückenlehne
geklappt (B x H x T)
60 x 77 x 10 cm

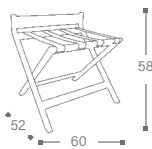

Ohne Rückenlehne
geklappt (B x H x T)
60 x 65 x 7 cm

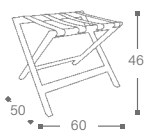

LUGGAGE RACK

With black straps
Material: wood, beech

With back
folded (W x H x D)
60 x 77 x 10 cm

080047 Buche, natur /
natural beech

080049 gebeizt, Mahagoni /
mahogany, stained

080086 gebeizt, schwarz /
black, stained

080043 Buche, natur /
natural beech

080045 gebeizt, Mahagoni /
mahogany stained

080089 schwarz /
black



Mahagoni, gebeizt / mahogany, stained

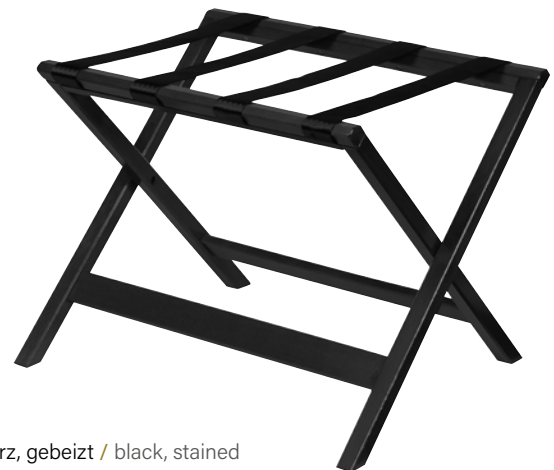

schwarz, gebeizt / black, stained



Buche, natur / natural beech

BÜGELSTATIONEN



IRONING SOLUTIONS





ENGINEERED FOR PERFORMANCE



- Automatische Abschaltung für mehr Sicherheit - horizontal nach 30 Sekunden / vertikal nach 8 Minuten
- Textilfreundliche Anti-Haft-Keramiksohle
- Maximale Wärmeregulung auf 200° C schützt Textilien bei Fehlbedienung
- Einfache Befüllung des Wassertanks mit Wasserstandsanzeige, Kapazität 200 ml/6.8 oz. /
- Automatic Hotel safety shut-off horizontal after 30 seconds/vertical after 8 minutes
- E-Z-glide non-stick CERAMIC soleplate
- Dial Fabric Control locks out at 200° C – guards against accidental scorching of fabric
- Easy front fill clear water tank: capacity 200 ml/6.8 oz.





- 01. Fingertip-Dampffunktion / Finger-tip Steam Function
- 02. Dampffunktion wahlweise mit komprimiertem Dampf- oder Wasserspray / Full-range spray adjustment with temperature control light
- 03. Temperatúrauswahl lässt sich auf unterschiedliche Textilien individuell einstellen / Rotating Fabric Control Dial for different textures
- 04. Ergonomischer Antirutsch-Griff ermöglicht bequemes Bügeln / Ergonomic anti-slip handle for comfortable ironing

160162
STEAMWORKS

Hotel-Dampfbügeleisen
weiß/silber
Energiesparend - 1650-2000 W
2-fach automatische
Sicherheitsabschaltung
- horizontal nach 30 Sekunden /
- vertikal nach 8 Minuten
Anti-Haft-Keramiksohle
Anti-Kalk- und Anti-Tropf-System
Selbstreinigungssystem
Kabellänge 2,4 m
Gewicht 1,1 kg

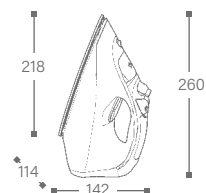
Hotel steam iron
white/silver
Energy saving - 1650-2000 W
Double safety automatic shut-off
-horizontal after 30 seconds/vertical after 8 minutes
Non-stick ceramic soleplate
Anti-calc and anti-drip system
Self cleaning system
Cord length 2.4 m
Weight 1.1 kg



Intertek   220-240 V, 50/60 Hz 1650-2000 W



SAHARA - Works When Dry





- 01. Anti-Haft-Beschichtung /
E-Z glide non-stick coating
- 02. 2-fach automatische Abschaltung /
Double safety automatic shut-off
- 03. Ergonomischer Antirutsch-Griff ermöglicht
bequemes Bügeln /
Ergonomic anti-slip handle for comfortable
ironing



160172
SAHARA

Hotel-Trockenbügelleisen
silber/champagner
EcoSmart - 900-1100 W
2-fach automatische Sicherheitsabschaltung
- horizontal nach 30 Sekunden /
- vertikal nach 8 Minuten
Temperaturregler
Anti-Haft-Keramiksohle
Kabellänge 2,4 m
Gewicht 0,8 kg

Hotel dry iron
silver/champagne
EcoSmart - 900-1100 W
Double safety automatic shut-off
- horizontal after 30 seconds/
- vertical after 8 minutes
Fabric control dial
Non-stick ceramic soleplate
Cord length 2.4 m
Weight 0.8 kg

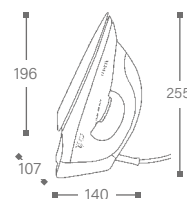

CE 220-240 V, 50/60 Hz 900-1100 W

On-Board Fixed Holder Design

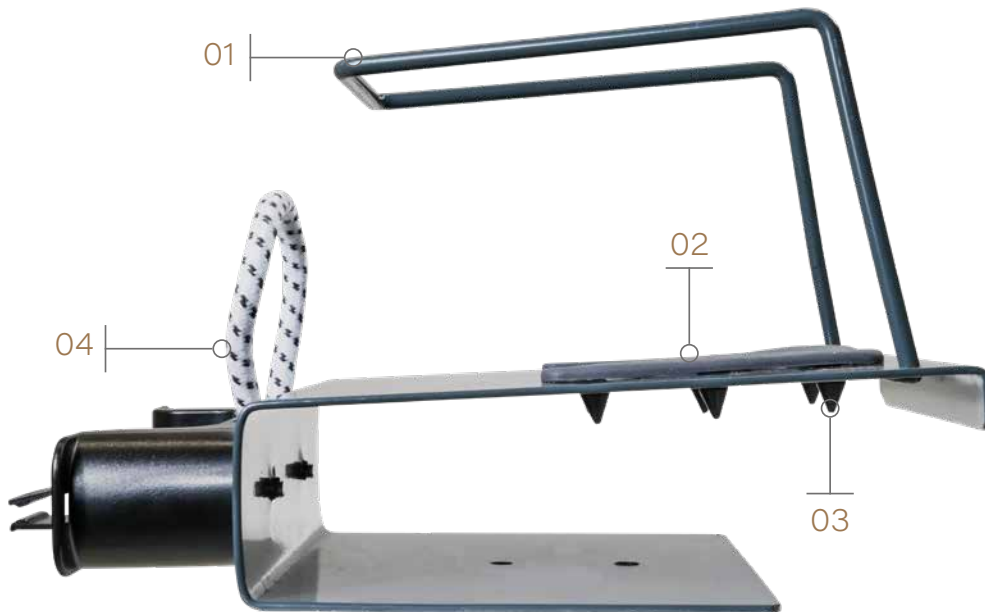

01. Passend für Trockenbügelleisen SAHARA und Dampfbügelleisen STEAMWORKS /
Accommodates both SAHARA dry Iron and STEAMWORKS steam iron
02. Bügelleisen liegt geschützt in der Halterung auf rutschfesten, hitzebeständigen Silikonstreifen /
Iron rests securely in place on heat resistant non-slip silicone bumpers
03. Austauschbare Silikonstreifen sind fixiert durch überstehende Noppen /
Replaceable bumpers are fastened to the holder via soft-pointed silicone inserts
04. Diebstahlsicher - Bügelleisenkabel wird durch die Halterung fest mit Bügelbrett verbunden /
Theft protection - cable secured through the holder/board



Integrierter Kabelhalter mit Kabelklemme
für eine saubere einfache Aufbewahrung /
Integrated Cable Reel and Clip for neat
easy storage



Elektroanschluss mit Netzkabel, 1,8 m Kabellänge /
Integrated Schuko extension cord, 1,8 m length



Diebstahlsichere Halterung zur Montage an
Tischbügeltisch MINI-MEEE, Bügeltisch MI-PRO
und MINI-MAX /

Theft proof thru-bolted holder directly onto Aliseo boards:
MI-PRO, MINI-MAX, MINI-MEE



Bügeleisen ist zur Schrankaufbewahrung in
hängender Position an seinem Platz gesichert /
Irons are secured safely in place for board
storage in hanging position





Doppelrohrkonstruktion
 - maximale Beanspruchbarkeit /
 Twin-tube construction
 - maximum strength

Stabiler rutschfester Gummifuß /
 Stable non-skid rubber footing

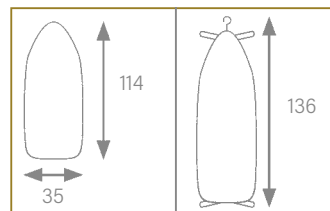

Gewicht / Weight

Bügelbrett / Board Mi-Pro	4,6 kg
Halterung / Holder	1,0 kg
Bügeleisen / Iron Sahara	0,8 kg
Bügeleisen / Iron SteamWorks	1,1 kg
Gesamt / Total	6,4 / 6,7 kg

Bügeleisen ist in hängender Position
 an seinem Platz gesichert /
 Irons are secured safely in place for
 board storage in hanging position

Bequemes Bügeln in der richtigen Höhe
 Höhenverstellbar 67-73-79-85 cm /
 Comfortable ironing at the right height
 Height adjustment 67-73-79-85 cm



MI-PRO

Bügelbrett mit Sicherheitshalterung
 Diebstahlsicher - Kabelrolle ist
 durch die Halterung gesichert
 Feuerfester, gepolsterter Bezug
 Höhenverstellbar 67-73-79-85 cm
 Elektroanschluss mit Netzkabel (1,8 m)
 Klappbarer Aufhängehaken
 Material Gestell: Stahlrohr
 Pulverbeschichtung, dunkelgrau

Ironing board with fixed safety iron holder
 Theft protection -
 cable reel secured through the holder
 Anti-Fire cover with foam underlay
 Height adjustable 67-73-79-85 cm
 Integrated Schuko extension cord (1,8 m)
 Fold-away suspension hook
 Material legs: tubular steel
 Powder coated dark grey finish

160200

MI-PRO SAHARA

Bügelbrett mit Sicherheitshalterung
 und Trockenbügeleisen /
 Ironing board with safety holder
 and dry iron

160203

MI-PRO STEAMWORKS

Bügelbrett mit Sicherheitshalterung
 und Dampfbügeleisen /
 Ironing board with safety holder
 and steam iron

160212

MI-PRO

Bügelbrett ohne Sicherheitshalterung /
 Ironing board without safety holder



Minimum Profile - Maximum Board Space

Speziell entwickelt für die Aufbewahrung in kleinen Schränken /
Specifically engineered for small cabinet storage



160219

MINI-MAX SAHARA

Bügelbrett mit Sicherheitshalterung
und Trockenbügelleisen /
Ironing board with safety holder
and dry iron

160222

MINI-MAX STEAMWORKS

Bügelbrett mit Sicherheitshalterung
und Dampfbügelleisen /
Ironing board with safety holder
and steam iron

160225

MINI-MAX

Bügelbrett ohne Sicherheitshalterung /
Ironing board without safety holder

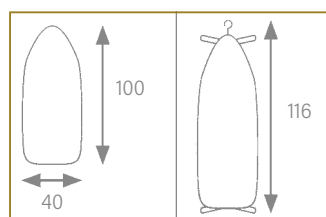

Gewicht / Weight

Bügelbrett / Board Mini-Max	4,7 kg
Halterung / Holder	1,0 kg
Bügelleisen / Iron Sahara	0,8 kg
Bügelleisen / Iron SteamWorks	1,1 kg
Gesamt / Total	6,5 / 6,8 kg

Für Sahara &
SteamWorks
Hotel-Bügeleisen
For Sahara &
SteamWorks
Hotel Irons



Bequemes Bügeln in der richtigen Höhe
Höhenverstellbar 60-63-66-69-72-75-78 cm /
Comfortable ironing at the right height
Height adjustment 60-63-66-69-72-75-78 cm



MINI-MAX

Bügelbrett mit Sicherheitshalterung
Diebstahlsicher - Kabelrolle ist durch die Halterung gesichert
Feuerfester, gepolsterter Bezug
Höhenverstellbar 60-63-66-69-72-75-78 cm
Elektroanschluss mit Netzkabel (1,8 m)
Klappbarer Aufhängehaken
Stabiles Gestell mit Transportsicherung
Material Gestell: Stahlrohr
Pulverbeschichtung, dunkelgrau /
Ironing board with fixed safety iron holder
Theft protection - cable reel secured through the holder
Anti-Fire cover with foam underlay
Height adjustable 60-63-66-69-72-75-78 cm
Integrated Schuko extension cord (1,8 m)
Fold-away suspension hook
Sturdy frame with transport safety lock
Material legs: tubular steel
Powder coated dark grey finish



ALISEO HANG-UP

Bügeleisenhalterung
 Hitzebeständige Rückwand
 Montage mit oder ohne Haken für
 Bügelbrett /
 Hang-up organizer
 Heat resistant back plate
 Mounted with or without
 board hanger

160130
 für Trockenbügelleisen Sahara
 schwarz /
 for dry iron Sahara
 black

160183
 für Dampfbügelleisen SteamWorks
 schwarz /
 for steam iron SteamWorks
 black

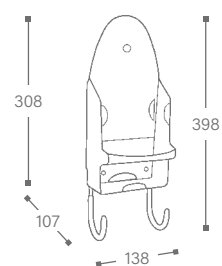

Hitzebeständige Eisenablage /
Heat Resistant Iron Rest



Bequemes Bügeln in der richtigen Höhe
Höhenverstellbar 90-96-102-108 cm /
Comfortable ironing at the right height
Height adjustment 90-96-102-108 cm

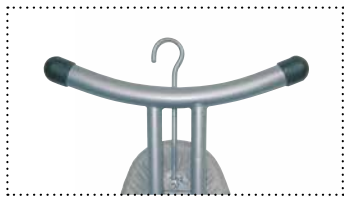

Klappbarer Aufhängehaken /
Fold-away suspension hook

Stabiler rutschfester Gummifuß /
Stable non-skid rubber footing



E-ZEE CONCEPT

Bügelbrett mit hitzebeständiger Bügeleisenablage
Feuerfester, gepolsterter Bezug
Höhenverstellbar 90-96-102-108 cm
Doppelrohrkonstruktion mit Transportsicherung
Material Gestell: Stahlrohr
Pulverbeschichtung, silber /
Ironing board with heat resistant iron rest
Anti-Fire cover with foam underlay
Height adjustment 90-96-102-108 cm
Durable double leg construction
with transport safety lock
Material legs: tubular steel
Powder coated silver finish



Elektroanschluss mit Netzkabel,
1,8 m Kabellänge /
Integrated Schuko extension cord,
1,8 m length

Gewicht / Weight

Bügelbrett / Board E-Zee	4,7 kg
Bügeleisen / Iron Sahara	0,8 kg
Bügeleisen / Iron SteamWorks	1,1 kg

160175
E-ZEE SAHARA
Bügelbrett mit Trockenbügeleisen /
Ironing board with dry iron

160167
E-ZEE STEAMWORKS
Bügelbrett mit Dampfbügeleisen /
Ironing board with steam iron

160111
E-ZEE
Bügelbrett /
Ironing board

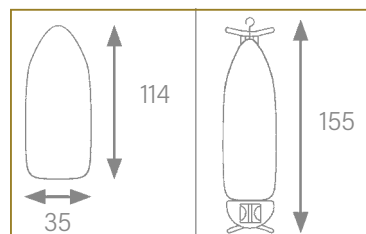

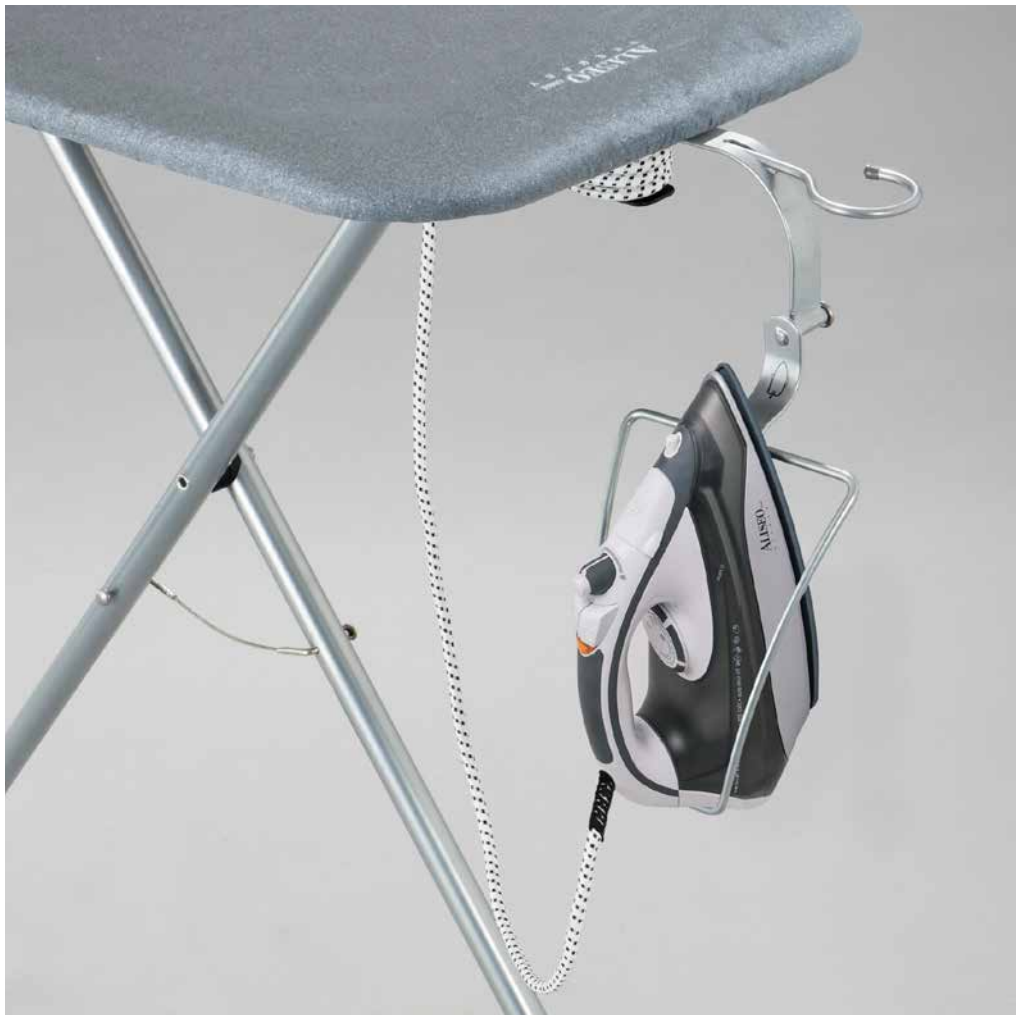

Elektroanschluss mit Netzkabel, 1,8 m Kabellänge /
Integrated Schuko extension cord, 1,8 m length

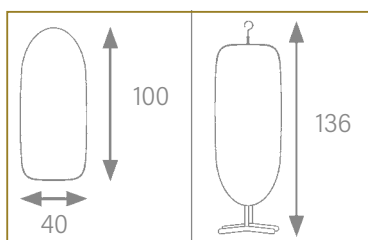

160178
SURF CENTER SAHARA
Bügelbrett mit Trockenbügelleisen /
Ironing board with dry iron

160164
SURF CENTER STEAMWORKS
Bügelbrett mit Dampfbügelleisen /
Ironing board with steam iron

160132
SURF BOARD
Bügelbrett ohne Bügelleisenhalterung /
Ironing board without iron safety cradle

SURF CENTER

Bügelbrett mit klappbarer Sicherheitshalterung
Feuerfester, gepolsterter Bezug
Höhenverstellbar 84-87-90 cm
Aufhängehaken
Stabiles Gestell mit Transportsicherung
Material Gestell: Stahlrohr
Pulverbeschichtung, silber /
Ironing board with fold-away safety cradle
Anti-Fire cover with foam underlay
Height adjustment 84-87-90 cm
Suspension hook
Sturdy frame with transport safety lock
Material legs: tubular steel
Powder coated silver finish

Gewicht / Weight

Bügelbrett / Board Surf	4,9 kg
Halterung / Holder	0,4 kg
Bügelleisen / Iron Sahara	0,8 kg
Bügelleisen / Iron SteamWorks	1,1 kg
Gesamt / Total	6,1 / 6,4 kg



Bequemes Bügeln in der richtigen Höhe
 Höhenverstellbar 84 - 87 - 90 cm /
 Comfortable ironing at the right height
 Height adjustment 84 - 87 - 90 cm













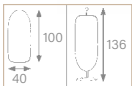

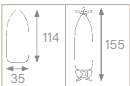

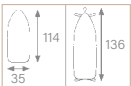

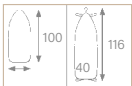

Diebstahlsicher – Kabel ist fest mit dem
 Bügelbrett verbunden /
 Anti-theft protection - cable
 guard secured through the board

Stabiler rutschfester Gummifuß /
 Stable non-skid rubber footing

Für Sahara &
 SteamWorks
 Hotel-Bügeleisen
 For Sahara &
 SteamWorks
 Hotel Irons

Modellübersicht / Product Overview

	SURF	E-ZEE	MI-PRO	MINI-MAX
<p>HANG-UP</p>  <p>160130 für Trockenbügelleisen Sahara / for Dry Iron Sahara</p> <p>160183 für Dampfbügelleisen SteamWorks / for Steam Iron SteamWorks</p>	  <p>160132 Bügelbrett Surf / Ironing Board Surf</p>	  <p>160111 Bügelbrett E-Zee / Ironing Board E-Zee</p>	  <p>160212 Bügelbrett Mi-Pro / Ironing Board Mi-Pro</p>	  <p>160225 Bügelbrett Mini-Max / Ironing Board Mini-Max</p>
 <p>SAHARA</p> <p>160172 Trockenbügelleisen Sahara / Dry Iron Sahara</p>	 <p>160178 Bügelbrett Surf & Sicherheitshalterung & Trockenbügelleisen Sahara / Ironing Board Surf & Safety Cradle & Dry Iron Sahara</p>	 <p>160175 Bügelbrett E-Zee & Trockenbügelleisen Sahara / Ironing Board E-Zee & Dry Iron Sahara</p>	 <p>160200 Bügelbrett Mi-Pro & Sicherheitshalterung & Trockenbügelleisen Sahara / Ironing Board Mi-Pro & Fixed Safety Holder & Dry Iron Sahara</p>	 <p>160219 Bügelbrett Mini-Max & Sicherheitshalterung & Trockenbügelleisen Sahara / Ironing Board Mini-Max & Fixed Safety Holder & Dry Iron Sahara</p>
 <p>STEAMWORKS</p> <p>160162 Dampfbügelleisen SteamWorks / Steam Iron SteamWorks</p>	 <p>160164 Bügelbrett Surf & Sicherheitshalterung & Dampfbügelleisen SteamWorks / Ironing Board Surf & Safety Cradle & Steam Iron SteamWorks</p>	 <p>160167 Bügelbrett E-Zee & Dampfbügelleisen SteamWorks / Ironing Board E-Zee & Steam Iron SteamWorks</p>	 <p>160203 Bügelbrett Mi-Pro & Sicherheitshalterung & Dampfbügelleisen SteamWorks / Ironing Board Mi-Pro & Fixed Safety Holder & Steam Iron SteamWorks</p>	 <p>160222 Bügelbrett Mini-Max & Sicherheitshalterung & Dampfbügelleisen SteamWorks / Ironing Board Mini-Max & Fixed Safety Holder & Steam Iron SteamWorks</p>



UNSER ÖKOLOGISCHES
ENGAGEMENT



OUR GREEN COMMITMENT



OUR GREEN COMMITMENT

Als umweltbewusstes Unternehmen verfolgt Aliseo nachhaltige und umweltfreundliche Geschäftspraktiken und hält die Qualitätsmanagementstandards gemäß ISO 9001:2015 ein.

Durch die ständige Prozessoptimierung zur Erweiterung der Produktlebenszyklen und die Bereitstellung einer zunehmenden Zahl an EcoSmart-Produkten strebt Aliseo weiterhin danach, das Bewusstsein von Hoteliers und ihren Gästen hinsichtlich des ökologischen globalen Engagements zu stärken.

Bereits heute an die Zukunft denken und Verantwortung übernehmen! Da Nachhaltigkeit und verantwortungsvolles Denken auch in unserem Unternehmen eine große Rolle spielen, verpflichten wir uns aus Eigeninitiative mit der Unterzeichnung der WIN-Charta zum nachhaltigen Wirtschaften.

Die WIN-Charta ist das einzige Nachhaltigkeitsmanagementsystem für kleine und mittlere Unternehmen in Deutschland. Darüber hinaus erfüllen alle Aliseo-Produkte die europäische Richtlinie zur Beschränkung der Verwendung bestimmter gefährlicher Stoffe. Wo immer möglich und wann immer es möglich ist, werden wiederverwertbare Materialien verwendet.

As an Environmentally Conscious Company, Aliseo is dedicated to ensuring sustainable and environmentally positive business practices and conforms to the quality management standards as defined by ISO 9001:2015.

By consistently developing processes that expand product life cycles and by providing an increasing number of EcoSmart products, Aliseo remains committed to increasing the consciousness of the hotelier and their guests to the importance of an ecological global commitment.

Taking responsibility for our future TODAY! Since sustainability and responsible thinking plays an important role in our company, we commit ourselves to sustainable business practices in accordance with WIN-Charta guidelines. WIN-Charta is the only sustainability management system for small and medium-sized enterprises in Germany. In addition all Aliseo products comply with the European Directive on the Restriction of Hazardous Substances. Where appropriate and whenever possible recyclable materials are used.



ALISEO GmbH
G E R M A N Y

Leutkirchstraße 63, 77723 Gengenbach, Germany
Tel. +49 (0) 78 03-60 279-0
Fax +49 (0) 78 03-60 279-30
Internet: www.aliseo.de
E-Mail: info@aliseo.de